

### 13. ΕΞΟΠΛΙΣΜΟΣ ΚΟΥΖΙΝΑΣ & ΝΤΟΥΛΑΠΑΣ





## 13.01 Αρμοκάλυπτρα πάγκων

Αρμοκάλυπτρο 210  
Κάθετη τοποθέτηση στον πάγκο

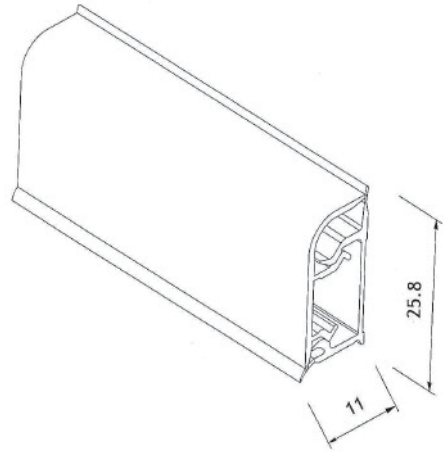

- ΑΡΜΟΚΑΛΥΠΤΡΟ 210

ΕΑΝ	ΚΩΔΙΚΟΣ			Μ.Μ.	
	131009.0000	4000mm	inox σαμπανιζέ	τεμ.	35



- ΓΩΝΙΕΣ & ΤΕΡΜΑΤΑ ΓΙΑ ΑΡΜΟΚΑΛΥΠΤΡΟ 210

ΕΑΝ	ΚΩΔΙΚΟΣ		Μ.Μ.	
	131002.0034	σαμπανιζέ	τεμ.	150





 13.01 Αρμοκάλυπτρα πάγκων

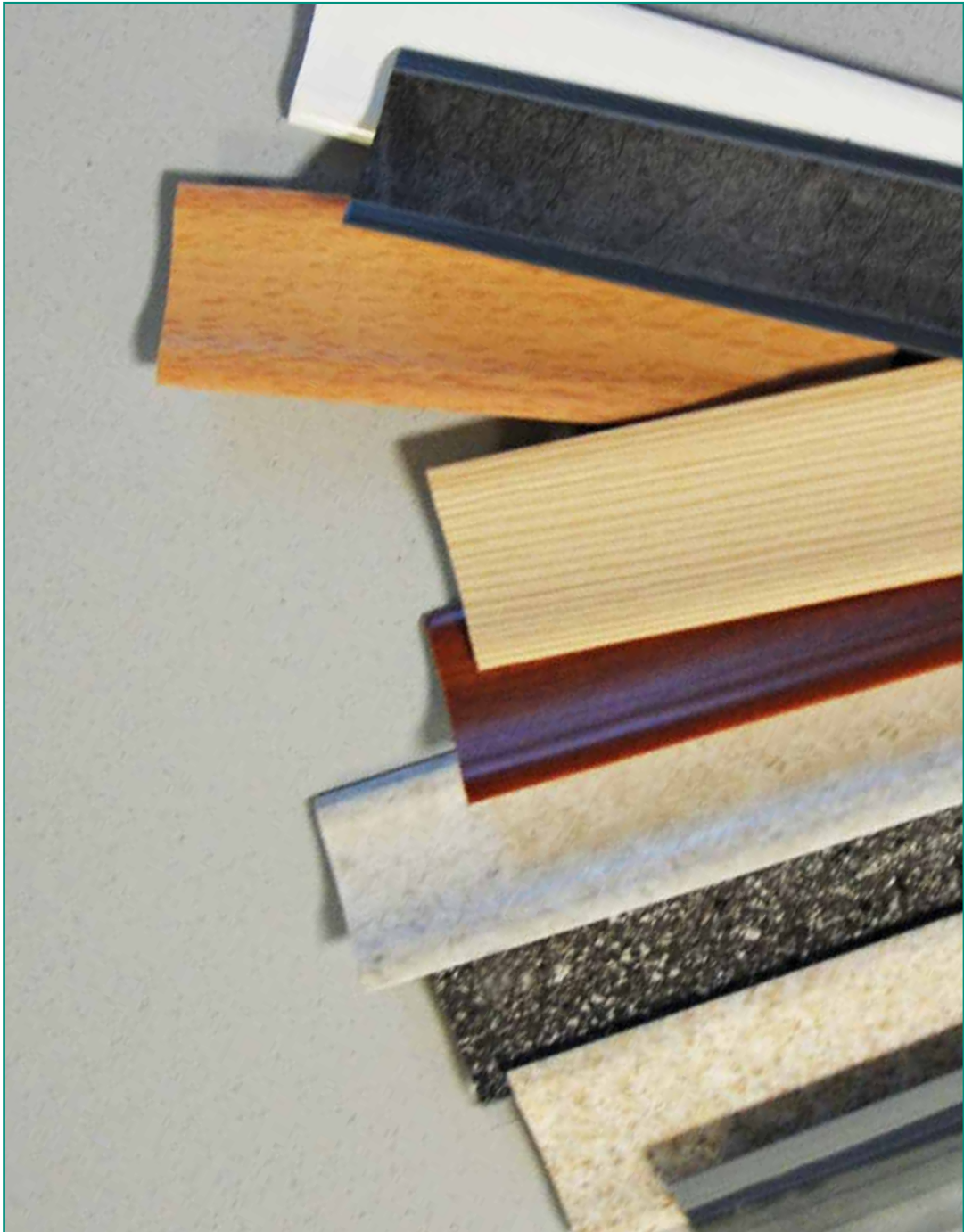

## 13.01 Αρμοκάλυπτρα πάγκων

- ΑΡΜΟΚΑΛΥΠΤΡΑ Η35mm

EAN	ΚΩΔΙΚΟΣ			Μ.Μ.		
 5 205566 168644	131006.0061 MRK120/899	4000mm	αλουμίνιο	μέτρο	100	
 5 205566 483082	131006.0078 MTK120/571	3000mm	δρυς	μέτρο	30	
 5 205566 483099	131006.0079 MTK120/689	3000mm	κερασιά	μέτρο	30	
 5 205566 484140	131006.0080 MTK120/287	3000mm	άμμος λευκό	μέτρο	30	
 5 205566 484157	131006.0081 WS MTK120/1004	3000mm	μάρμαρο σομόν	μέτρο	30	
 5 205566 484164	131006.0082 MTK120/301	3000mm	ματ λευκό	μέτρο	30	
 5 205566 484171	131006.0083 MTK120/206	3000mm	wenge	μέτρο	30	
 5 205566 484195	131006.0084 MTK120/404	3000mm	κερασιά	μέτρο	30	

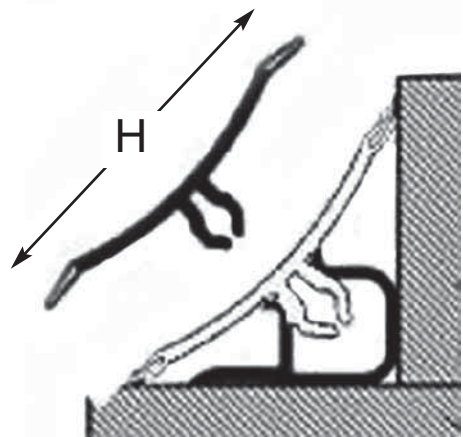



### 13.01 Αρμολάμπτες πάγκων

• ΓΩΝΙΕΣ ΑΡΜΟΚΑΛΥΠΤΡΟΥ ΕΣΩΤΕΡΙΚΕΣ

ΕΑΝ	ΚΩΔΙΚΟΣ		Μ.Μ	
	131007.0047 ΕΣΩΤΕΡΙΚΗ ΜΤΚ120/899	αλουμίνιο	τεμ.	25
	131007.0095 ΕΣΩΤΕΡΙΚΗ ΜΤΚ120/571	δρυς	τεμ.	25
	131007.0098 ΕΣΩΤΕΡΙΚΗ ΜΤΚ120/689	κερασιά	τεμ.	25
	131007.0101 ΕΣΩΤΕΡΙΚΗ ΜΤΚ120/287	άμμος λευκό	τεμ.	25
	131007.0104 ΕΣΩΤΕΡΙΚΗ ΜΤΚ120/1004	μάρμαρο λευκό	τεμ.	25
	131007.0107 ΕΣΩΤΕΡΙΚΗ ΜΤΚ120/301	λευκό ματ	τεμ.	25
	131007.0110 ΕΣΩΤΕΡΙΚΗ ΜΤΚ120/206	wenge	τεμ.	25
	131007.0113 ΕΣΩΤΕΡΙΚΗ ΜΤΚ120/404	οξιά	τεμ.	25

• ΓΩΝΙΕΣ ΑΡΜΟΚΑΛΥΠΤΡΟΥ ΕΞΩΤΕΡΙΚΕΣ

ΕΑΝ	ΚΩΔΙΚΟΣ		Μ.Μ	
	131007.0048 ΕΞΩΤΕΡΙΚΗ ΜΤΚ120/899	αλουμίνιο	τεμ.	25
	131007.0094 ΕΞΩΤΕΡΙΚΗ ΜΤΚ120/571	δρυς	τεμ.	25
	131007.0097 ΕΞΩΤΕΡΙΚΗ ΜΤΚ120/689	κερασιά	τεμ.	25
	131007.0100 ΕΞΩΤΕΡΙΚΗ ΜΤΚ120/287	άμμος λευκό	τεμ.	25
	131007.0103 ΕΞΩΤΕΡΙΚΗ ΜΤΚ120/1004	μάρμαρο λευκό	τεμ.	25
	131007.0106 ΕΞΩΤΕΡΙΚΗ ΜΤΚ120/301	λευκό ματ	τεμ.	25
	131007.0109 ΕΞΩΤΕΡΙΚΗ ΜΤΚ120/206	wenge	τεμ.	25
	131007.0112 ΕΞΩΤΕΡΙΚΗ ΜΤΚ120/404	οξιά	τεμ.	25

• ΤΕΡΜΑΤΑ ΑΡΜΟΚΑΛΥΠΤΡΟΥ

ΕΑΝ	ΚΩΔΙΚΟΣ		Μ.Μ	
	131007.0046 ΜΤΚ120/899	αλουμίνιο	τεμ.	25
	131007.0096 ΜΤΚ120/571	δρυς	τεμ.	25
	131007.0099 ΜΤΚ120/689	κερασιά	τεμ.	25
	131007.0102 ΜΤΚ120/287	άμμος λευκό	τεμ.	25

ΕΑΝ	ΚΩΔΙΚΟΣ		Μ.Μ	
	131007.0105 ΜΤΚ120/1004	μάρμαρο λευκό	τεμ.	25
	131007.0108 ΜΤΚ120/301	λευκό ματ	τεμ.	25
	131007.0111 ΜΤΚ120/206	wenge	τεμ.	25
	131007.0114 ΜΤΚ120/404	οξιά	τεμ.	25

13.01 Αρμοκάλυπτρα πάγκων

- ΑΡΜΟΚΑΛΥΠΤΡΑ Η35mm

ΕΑΝ	ΚΩΔΙΚΟΣ			Μ.Μ.		
	131006.0073 MTK120/899	3000mm	αλουμίνιο	τεμ.	10	
	131006.0062 MTK120/1105	3000mm	λευκό γυαλ.	τεμ.	10	
	131006.0063 MTK120/193	3000mm	μάρμαρο μπεζ	τεμ.	10	
	131006.0064 MTK120/283	3000mm	οξιά ανοιχτό	τεμ.	10	
	131006.0065 MTK120/116	3000mm	δρυς ανοιχτό	τεμ.	10	
	131006.0066 MTK120/288	3000mm	γρανίτης σκούρος	τεμ.	10	
	131006.0067 MTK120/1517	3000mm	γρανίτης πέτρα	τεμ.	10	
	131006.0068 MTK120/284	3000mm	ανθρακί	τεμ.	10	
	131006.0069 MTK120/221	3000mm	λευκό arabeska	τεμ.	10	
	131006.0070 MTK120/1515	3000mm	μάρμαρο	τεμ.	10	
	131006.0071 MTK120/1512	3000mm	γρανίτης μπεζ	τεμ.	10	
	131006.0072 MTK120/097	3000mm	καρυδιά	τεμ.	10	



## 13.01 Αρμοκάλυπτρα πάγκων

### • ΓΩΝΙΕΣ ΑΡΜΟΚΑΛΥΠΤΡΟΥ ΕΣΩΤΕΡΙΚΕΣ

EAN	ΚΩΔΙΚΟΣ		Μ.Μ	
 5 205566 168668	131007.0047 ΕΞΩΤ.ΜΤΚ120/899	αλουμίνιο	τεμ.	25
 5 205566 437092	131007.0050 ΕΞΩΤ.ΜΤΚ120/1105	λευκό γυαλ.	τεμ.	25
 5 205566 437122	131007.0053 ΕΞΩΤ.ΜΤΚ120/193	μπεζ	τεμ.	25
 5 205566 437238	131007.0056 ΕΞΩΤ.ΜΤΚ120/283	οξιά ανοιχτό	τεμ.	25
 5 205566 437269	131007.0059 ΕΞΩΤ.ΜΤΚ120/116	δρυς ανοιχτό	τεμ.	25
 5 205566 437290	131007.0062 ΕΞΩΤ.ΜΤΚ120/288	γρανίτης σκούρος	τεμ.	25
 5 205566 437320	131007.0065 ΕΞΩΤ.ΜΤΚ120/1517	γρανίτης πέτρα	τεμ.	25
 5 205566 437375	131007.0068 ΕΞΩΤ.ΜΤΚ120/284	ανθρακί	τεμ.	25
 5 205566 437412	131007.0071 ΕΞΩΤ.ΜΤΚ120/221	λευκό arabeska	τεμ.	25
 5 205566 437467	131007.0074 ΕΞΩΤ.ΜΤΚ120/1515	μάρμαρο	τεμ.	25
 5 205566 437498	131007.0077 ΕΞΩΤ.ΜΤΚ120/1512	γρανίτης μπεζ	τεμ.	25
 5 205566 437771	131007.0080 ΕΞΩΤ. ΜΤΚ120/097	καρυδιά	τεμ.	25

### • ΓΩΝΙΕΣ ΑΡΜΟΚΑΛΥΠΤΡΟΥ ΕΞΩΤΕΡΙΚΕΣ

EAN	ΚΩΔΙΚΟΣ		Μ.Μ	
 5 205566 168675	131007.0048 ΕΞΩΤ.ΜΤΚ120/899	αλουμίνιο	τεμ.	25
 5 205566 437108	131007.0051 ΕΞΩΤ.ΜΤΚ120/1105	λευκό γυαλ.	τεμ.	25
 5 205566 437139	131007.0054 ΕΞΩΤ.ΜΤΚ120/193	μπεζ	τεμ.	25
 5 205566 437245	131007.0057 ΕΞΩΤ.ΜΤΚ120/283	οξιά ανοιχτό	τεμ.	25
 5 205566 437276	131007.0060 ΕΞΩΤ.ΜΤΚ120/116	δρυς ανοιχτό	τεμ.	25
 5 205566 437306	131007.0063 ΕΞΩΤ.ΜΤΚ120/288	γρανίτης σκούρος	τεμ.	25
 5 205566 437337	131007.0066 ΕΞΩΤ.ΜΤΚ120/1517	γρανίτης πέτρα	τεμ.	25
 5 205566 437382	131007.0069 ΕΞΩΤ.ΜΤΚ120/284	ανθρακί	τεμ.	25
 5 205566 437436	131007.0072 ΕΞΩΤ.ΜΤΚ120/221	λευκό arabeska	τεμ.	25
 5 205566 437474	131007.0075 ΕΞΩΤ.ΜΤΚ120/1515	μάρμαρο	τεμ.	25
 5 205566 437511	131007.0078 ΕΞΩΤ.ΜΤΚ120/1512	γρανίτης μπεζ	τεμ.	25
 5 205566 437832	131007.0081 ΕΞΩΤ.ΜΤΚ120/097	καρυδιά	τεμ.	25

### • ΤΕΡΜΑΤΑ ΑΡΜΟΚΑΛΥΠΤΡΟΥ

EAN	ΚΩΔΙΚΟΣ		Μ.Μ	
 5 205566 168651	131007.0046 ΜΤΚ120/899	αλουμίνιο	τεμ.	25
 5 205566 437085	131007.0049 ΜΤΚ120/1105	λευκό γυαλ.	τεμ.	25
 5 205566 437115	131007.0052 ΜΤΚ120/193	μπεζ	τεμ.	25
 5 205566 437177	131007.0055 ΜΤΚ120/283	οξιά ανοιχτό	τεμ.	25
 5 205566 437252	131007.0058 ΜΤΚ120/116	δρυς ανοιχτό	τεμ.	25
 5 205566 437283	131007.0061 ΜΤΚ120/288	γρανίτης σκούρος	τεμ.	25

EAN	ΚΩΔΙΚΟΣ		Μ.Μ	
 5 205566 437313	131007.0064 ΜΤΚ120/1517	γρανίτης πέτρα	τεμ.	25
 5 205566 437368	131007.0067 ΜΤΚ120/284	ανθρακί	τεμ.	25
 5 205566 437405	131007.0070 ΜΤΚ120/221	λευκό arabeska	τεμ.	25
 5 205566 437450	131007.0073 ΜΤΚ120/1515	μάρμαρο	τεμ.	25
 5 205566 437481	131007.0076 ΜΤΚ120/1512	γρανίτης μπεζ	τεμ.	25
 5 205566 437603	131007.0079 ΜΤΚ120/097	καρυδιά	τεμ.	25

## 13.01 Αρμοκάλυπτρα πάγκων



• ΑΡΜΟΚΑΛΥΠΤΡΑ ΛΕΠΤΑ Η22mm

ΕΑΝ	ΚΩΔΙΚΟΣ			Μ.Μ.	
 5 205566 436965	131006.0074 MRK494/201	3000mm	λευκό	τεμ.	32
 5 205566 436989	131006.0075 MRK494/203	3000mm	αλουμίνιο	τεμ.	32
 5 205566 437054	131006.0076 MTK636/235	3000mm	μπεζ	τεμ.	32



• ΓΩΝΙΕΣ ΑΡΜΟΚΑΛΥΠΤΡΟΥ ΕΣΩΤΕΡΙΚΕΣ

ΕΑΝ	ΚΩΔΙΚΟΣ		Μ.Μ.	
 5 205566 438013	131007.0083 ΕΣΩΤΕΡΙΚΗ MRK494/201	λευκό	τεμ.	50
 5 205566 438754	131007.0086 ΕΣΩΤΕΡΙΚΗ MRK494/203	αλουμίνιο	τεμ.	50
 5 205566 438808	131007.0089 ΕΣΩΤΕΡΙΚΗ MTK636/235	μπεζ	τεμ.	50

• ΓΩΝΙΕΣ ΑΡΜΟΚΑΛΥΠΤΡΟΥ ΕΞΩΤΕΡΙΚΕΣ

ΕΑΝ	ΚΩΔΙΚΟΣ		Μ.Μ.	
 5 205566 438730	131007.0084 ΕΞΩΤΕΡΙΚΗ MRK494/201	λευκό	τεμ.	50
 5 205566 438785	131007.0087 ΕΞΩΤΕΡΙΚΗ MRK494/203	αλουμίνιο	τεμ.	50
 5 205566 438815	131007.0090 ΕΞΩΤΕΡΙΚΗ MTK636/235	μπεζ	τεμ.	50

• ΤΕΡΜΑΤΑ ΑΡΜΟΚΑΛΥΠΤΡΟΥ

ΕΑΝ	ΚΩΔΙΚΟΣ		Μ.Μ.	
 5 205566 437924	131007.0082 MRK494/201	λευκό	τεμ.	100
 5 205566 438747	131007.0085 MRK494/203	αλουμίνιο	τεμ.	100
 5 205566 438792	131007.0088 MTK636/235	μπεζ	τεμ.	100





**13.01 Αρμοκάλυπτρα πάγκων**



- ΑΡΜΟΚΑΛΥΠΤΡΟ ΠΟΜΠΕ Η30mm

ΕΑΝ	ΚΩΔΙΚΟΣ			Μ.Μ.	
 5 205566 437061	131006.0077 MRK630/1200	3000mm	αλουμίνιο	τεμ.	8



- ΓΩΝΙΑ ΑΡΜΟΚΑΛΥΠΤΡΟΥ ΠΟΜΠΕ ΕΣΩΤΕΡΙΚΗ

ΕΑΝ	ΚΩΔΙΚΟΣ		Μ.Μ.	
 5 205566 467624	131007.0092 ΕΣΩΤΕΡΙΚΗ MRK630/1200	αλουμίνιο	τεμ.	50

- ΓΩΝΙΑ ΑΡΜΟΚΑΛΥΠΤΡΟΥ ΠΟΜΠΕ ΕΞΩΤΕΡΙΚΗ

ΕΑΝ	ΚΩΔΙΚΟΣ		Μ.Μ.	
 5 205566 467648	131007.0093 ΕΞΩΤΕΡΙΚΗ MRK630/1200	αλουμίνιο	τεμ.	50

- ΤΕΡΜΑ ΑΡΜΟΚΑΛΥΠΤΡΟΥ ΠΟΜΠΕ

ΕΑΝ	ΚΩΔΙΚΟΣ		Μ.Μ.	
 5 205566 438839	131007.0091 MRK630/1200	αλουμίνιο	τεμ.	100

## 13.02 Μπάζες και ποδαράκια

- ΜΠΑΖΑ PVC 4000mm

ΕΑΝ	ΚΩΔΙΚΟΣ			Μ.Μ.	
	131101.0012	H100mm	αλουμίνιο	μέτρο	60 (15β)
	131101.0013	H120mm	αλουμίνιο	μέτρο	60
	131101.0014	H150mm	αλουμίνιο	μέτρο	60



- ΓΩΝΙΑ ΜΠΑΖΑΣ ΕΣΩΤΕΡΙΚΗ & ΕΞΩΤΕΡΙΚΗ 90°

ΕΑΝ	ΚΩΔΙΚΟΣ			Μ.Μ.	
	131102.0030	H97mm	αλουμίνιο	τεμ.	1
	131102.0031	H117mm	αλουμίνιο	τεμ.	1
	131102.0032	H147mm	αλουμίνιο	τεμ.	1



- ΠΟΔΙ ΜΠΑΖΑΣ ΜΕ ΦΑΡΔΥ ΠΕΛΜΑ (ρύθμιση καθ' ύψος : -5 +10)

ΕΑΝ	ΚΩΔΙΚΟΣ			Μ.Μ.	
	140401.0003	H100mm	μαύρο	τεμ.	300
	140401.0005	H150mm	μαύρο	τεμ.	300

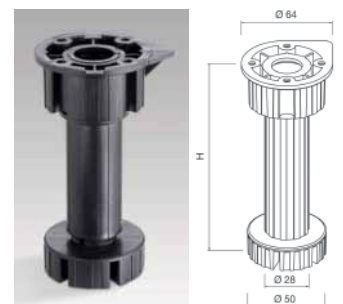

- ΓΑΝΤΖΟΣ ΠΛΑΣΤΙΚΟΣ ΓΙΑ ΠΟΔΙΑ ΜΠΑΖΑΣ

ΕΑΝ	ΚΩΔΙΚΟΣ			Μ.Μ.	
	140413.0000	H100mm	μαύρο	τεμ.	1



## 13.02 Μπάζες και ποδαράκια

- ΠΟΔΙ ΜΠΑΖΑΣ ΠΛΑΣΤΙΚΟ ΜΕ ΣΤΕΝΟ ΡΕΓΟΥΛΑΤΟΡΟ

ΕΑΝ	ΚΩΔΙΚΟΣ			Μ.Μ.	
	140402.0001	H100mm	λευκό	τεμ.	300



- ΠΟΔΙ ΜΠΑΝΙΟΥ ΠΛΑΣΤΙΚΟ

ΕΑΝ	ΚΩΔΙΚΟΣ			Μ.Μ.	
	140402.0003	H70mm	λευκό	τεμ.	400



- ΠΙΑΣΤΡΑ ΜΠΑΖΑΣ ΠΛΑΣΤΙΚΗ

ΕΑΝ	ΚΩΔΙΚΟΣ		Μ.Μ.	
	140409.0000	λευκό	τεμ.	100







- ΠΟΔΙ ΔΙΑΚΟΣΜΗΤΙΚΟ ΠΛΑΣΤΙΚΟ

ΕΑΝ	ΚΩΔΙΚΟΣ			Μ.Μ.	
	140405.0000	H100mm	νίκελ ματ	τεμ.	100





## 13.02 Μπάζες και ποδαράκια

- ΠΟΔΙ ΜΠΑΖΑΣ ΠΛΑΣΤΙΚΟ "SAMAR" ΜΕ ΦΑΡΔΥ ΠΕΛΜΑ

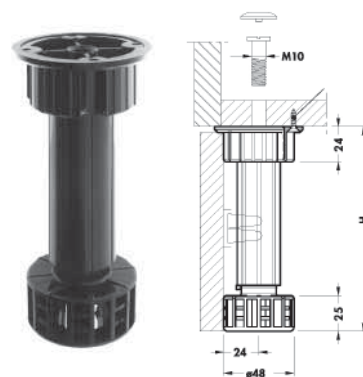
ΕΑΝ	ΚΩΔΙΚΟΣ			Μ.Μ.	
	140403.0006	H100mm	μαύρο	τεμ.	400







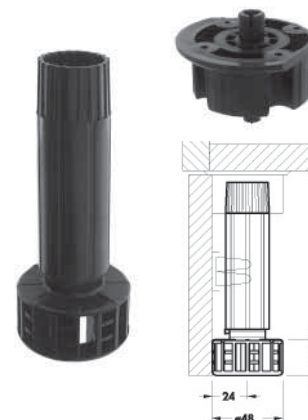



- ΠΟΔΙ ΜΠΑΖΑΣ ΠΛΑΣΤΙΚΟ "SAMAR" ΜΕ ΦΑΡΔΥ ΠΕΛΜΑ ΔΙΑΙΡΟΥΜΕΝΟ

ΕΑΝ	ΚΩΔΙΚΟΣ			Μ.Μ.	
	140403.0003 ΠΟΔΙ	H100mm	μαύρο	τεμ.	400
	140403.0005 ΒΑΣΗ	Dubel Φ10mm	μαύρο	τεμ.	400



- ΠΟΔΙ ΜΠΑΖΑΣ ΜΕΤΑΛΛΙΚΟ "SAMAR" 50mm

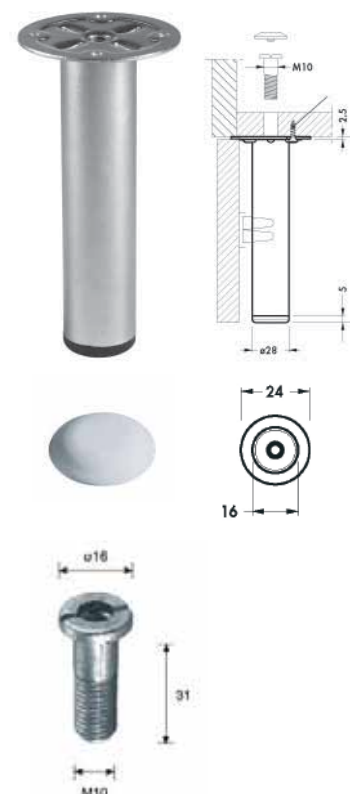

ΕΑΝ	ΚΩΔΙΚΟΣ			Μ.Μ.	
	140404.0002 ΠΟΔΙ	H45mm	νίκελ	τεμ.	200
	140404.0001 ΡΕΓΟΥΛΑΤΟΡΟΣ	H5mm	μαύρο	τεμ.	800
	140404.0003 ΤΑΠΑ	Φ24mm	λευκό	τεμ.	400
	140404.0006 ΤΑΠΑ	Φ24mm	μαύρο	τεμ.	400
	140404.0007 ΤΑΠΑ	Φ24mm	μπεζ	τεμ.	400
	140404.0004 ΚΕΝΤΡΙΚΗ ΒΙΔΑ	M10x31mm	νίκελ	τεμ.	400





## 13.02 Μπάζες και ποδαράκια

- ΠΙΑΣΤΡΑ ΜΠΑΖΑΣ ΠΛΑΣΤΙΚΗ "CAMAR" ΣΥΡΤΑΡΩΤΗ

ΕΑΝ	ΚΩΔΙΚΟΣ		Μ.Μ.	
	140408.0000 ΓΑΝΤΖΟΣ	μαύρο	τεμ.	800
	140408.0002 ΒΑΣΗ	μαύρο	τεμ.	800

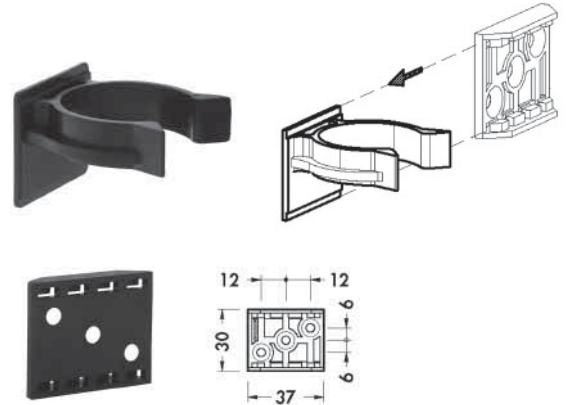





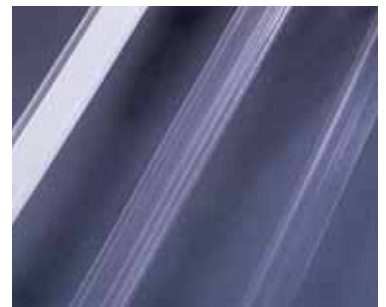



- ΜΟΝΩΤΙΚΟ ΜΠΑΖΑΣ

ΕΑΝ	ΚΩΔΙΚΟΣ			Μ.Μ.	
	131301.0000	16mm	καφέ	μετρό	75
	131301.0001	16mm	διαφανές	μετρό	75



## 13.04 Υγροσυλλέκτες

- ΥΓΡΟΣΥΛΛΕΚΤΕΣ - ΒΑΣΕΙΣ ΑΛΟΥΜΙΝΙΟΥ

ΕΑΝ	ΚΩΔΙΚΟΣ			Μ.Μ.	
	130601.0010	600mm	αλουμίνιο	τεμ.	36
	130601.0011	800mm	αλουμίνιο	τεμ.	36
	130601.0012	900mm	αλουμίνιο	τεμ.	36
	130601.0013	1000mm	αλουμίνιο	τεμ.	36
	130601.0014	1200mm	αλουμίνιο	τεμ.	36

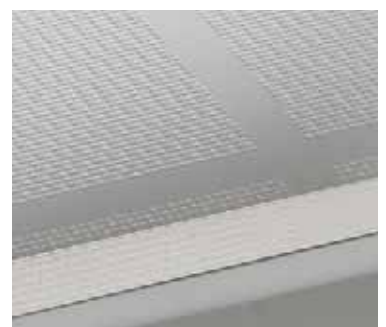





13.03 Κουταλοθήκες









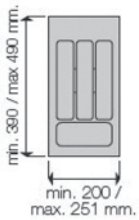

### 13.03 Κουταλοθήκες

- Κουταλοθήκη πλαστική 200-251 x 390-490 mm, για κουτί 300mm

ΕΑΝ	ΚΩΔΙΚΟΣ			Μ.Μ.	
 512055661393336	130805.0023	200-251mm 390-490mm	γκρι	τεμ.	25
 512055661355662	130805.0018	200-251mm 390-490mm	λευκό	τεμ.	25





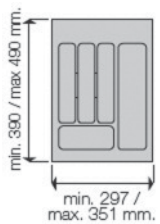

- Κουταλοθήκη πλαστική 297-351 x 390-490 mm, για κουτί 400mm

ΕΑΝ	ΚΩΔΙΚΟΣ			Μ.Μ.	
 512055661393381	130805.0024	297-351mm 390-490mm	γκρι	τεμ.	25
 512055661355990	130805.0019	297-351mm 390-490mm	λευκό	τεμ.	25





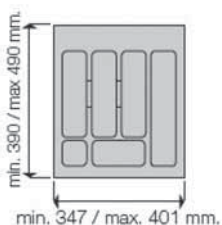

- Κουταλοθήκη πλαστική 347-401 x 390-490 mm, για κουτί 450mm

ΕΑΝ	ΚΩΔΙΚΟΣ			Μ.Μ.	
 512055661393398	130805.0025	347-401mm 390-490mm	γκρι	τεμ.	25
 512055661356218	130805.0020	347-401mm 390-490mm	λευκό	τεμ.	25





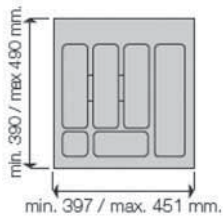

13.03 Κουταλοθήκες

- Κουταλοθήκη πλαστική 397-451 x 390-490 mm, για κουτί 500mm

EAN	ΚΩΔΙΚΟΣ			Μ.Μ.	
 5120556613934041	130805.0026	397-451mm 390-490mm	γκρι	τεμ.	20
 5120556613569661	130805.0021	397-451mm 390-490mm	λευκό	τεμ.	20





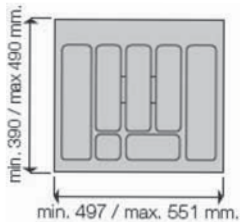

- Κουταλοθήκη πλαστική 497-551 x 390-490 mm, για κουτί 600mm

EAN	ΚΩΔΙΚΟΣ			Μ.Μ.	
 5120556613934111	130805.0027	497-551mm 390-490mm	γκρι	τεμ.	20
 5120556613572151	130805.0022	497-551mm 390-490mm	λευκό	τεμ.	20



- Κουταλοθήκη πλαστική 697-740 x 390-490 mm, για κουτί 800mm

EAN	ΚΩΔΙΚΟΣ			Μ.Μ.	
 5120556613934281	130805.0028	697-740mm 390-490mm	γκρι	τεμ.	10

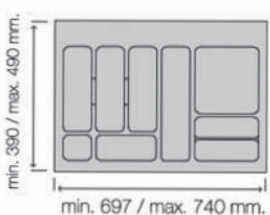





### 13.03 Κουταλοθήκες

- Κουταλοθήκη πλαστική 795-840 x 390-490 mm, για κουτί 900mm

ΕΑΝ	ΚΩΔΙΚΟΣ			Μ.Μ.	
	130805.0029	795-840mm 390-490mm	γκρι	τεμ.	10

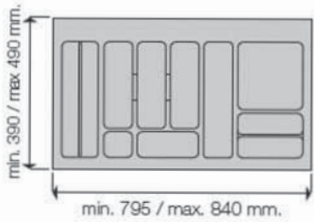

- Κουταλοθήκη πλαστική 895-940 x 390-490 mm, για κουτί 1000mm

ΕΑΝ	ΚΩΔΙΚΟΣ			Μ.Μ.	
	130805.0030	895-940mm 390-490mm	γκρι	τεμ.	5

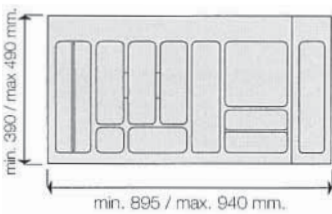





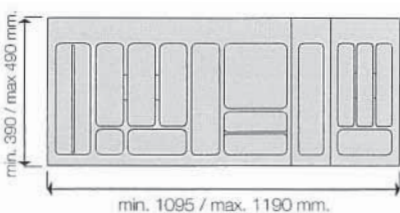



- Κουταλοθήκη πλαστική 1095-1190 x 390-490 mm, για κουτί 1200mm

ΕΑΝ	ΚΩΔΙΚΟΣ			Μ.Μ.	
	130805.0031	1095-1190mm 390-490mm	γκρι	τεμ.	5











## 13.04 Πιατοθήκες

- ΠΙΑΤΟΘΗΚΗ ΚΡΕΜΑΣΤΗ

ΕΑΝ	ΚΩΔΙΚΟΣ			Μ.Μ.	
 5205566114535	130904.0006	565mm	χρώμιο	τεμ.	1
 5205566114603	130904.0007	665mm	χρώμιο	τεμ.	1
 5205566114627	130904.0008	765mm	χρώμιο	τεμ.	1
 5205566114641	130904.0009	865mm	χρώμιο	τεμ.	1
 5205566114672	130904.0010	965mm	χρώμιο	τεμ.	1
 5205566114702	130904.0011	1065mm	χρώμιο	τεμ.	1



- ΠΙΑΤΟΘΗΚΗ ΚΡΕΜΑΣΤΗ/ΚΑΘΙΣΤΗ

ΕΑΝ	ΚΩΔΙΚΟΣ			Μ.Μ.	
 5205566114450	130904.0000	565mm	χρώμιο	τεμ.	1
 5205566114467	130904.0001	665mm	χρώμιο	τεμ.	1
 5205566114481	130904.0002	765mm	χρώμιο	τεμ.	1
 5205566114498	130904.0003	865mm	χρώμιο	τεμ.	1
 5205566114504	130904.0004	965mm	χρώμιο	τεμ.	1
 5205566114528	130904.0005	1065mm	χρώμιο	τεμ.	1



- ΣΤΗΡΙΓΜΑΤΑ ΠΙΑΤΟΘΗΚΩΝ

ΕΑΝ	ΚΩΔΙΚΟΣ		Μ.Μ.	
 5205566114726	130904.0013 ΜΙΚΡΟ	νίκελ	τεμ.	1
 5205566114719	130904.0012 ΜΕΓΑΛΟ	ανοξειδωτο	τεμ.	1





### 13.05 Αναρτήρες ντουλαπιών



#### ΑΝΑΡΤΗΡΑΣ CAMAR - ART.806

- ΑΝΑΡΤΗΡΑΣ ΒΙΔΩΤΟΣ ART.806

LGA	DIN 68840	50 kg
-----	-----------	-------

ΕΑΝ	ΚΩΔΙΚΟΣ		Μ.Μ.	
 520556611875221	132001.0003	λευκό	τεμ.	200

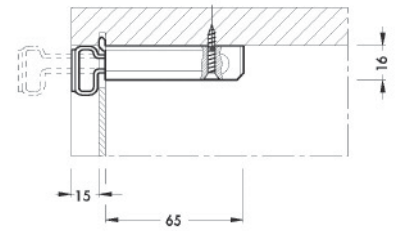
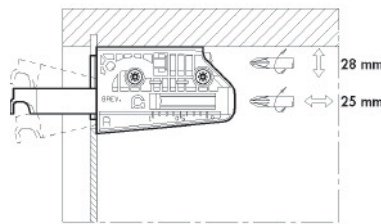
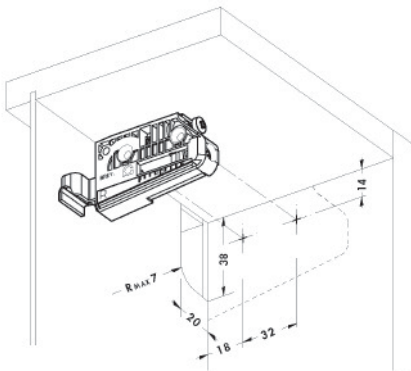

- ΑΝΑΡΤΗΡΑΣ ΜΕ ΔΥΒΕΛ Φ10mm ART.806

LGA	DIN 68840	65 kg
-----	-----------	-------

ΕΑΝ	ΚΩΔΙΚΟΣ		Μ.Μ.	
 52055661187065	132001.0004	λευκό	τεμ.	200

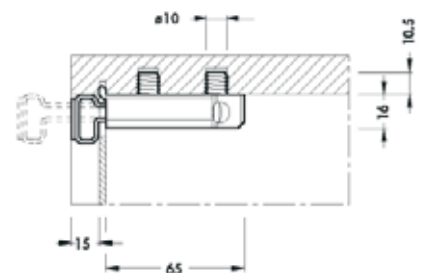
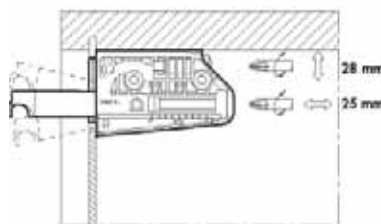
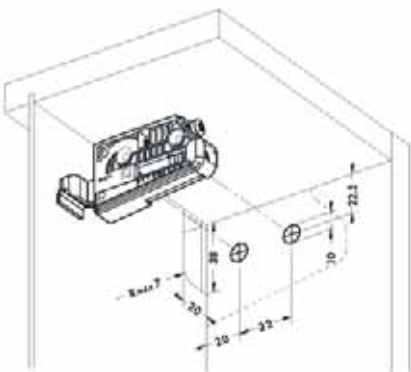

## 13.05 Αναρτήρες ντουλαπιών



### ΑΝΑΡΤΗΡΑΣ CAMAR - ART.806

- ΚΑΠΑΚΙΑ ΑΝΑΡΤΗΡΩΝ ART.806

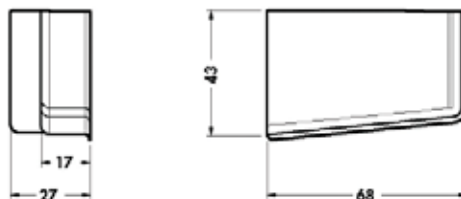
ΕΑΝ	ΚΩΔΙΚΟΣ		Μ.Μ.	
	132002.0002	νίκελ	τεμ.	400
	132002.0000	λευκό	τεμ.	400
	132002.0001	καφέ	τεμ.	400



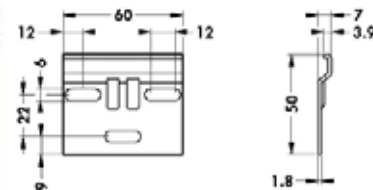

- ΛΑΜΑΚΙ ΣΤΗΡΙΞΗΣ ΑΝΑΡΤΗΡΩΝ ART.806

ΕΑΝ	ΚΩΔΙΚΟΣ		Μ.Μ.	
	132003.0000	νίκελ	τεμ.	400





### ΑΝΑΡΤΗΡΑΣ CAMAR - ART.802

- ΑΝΑΡΤΗΡΑΣ ΒΙΔΩΤΟΣ ART.802

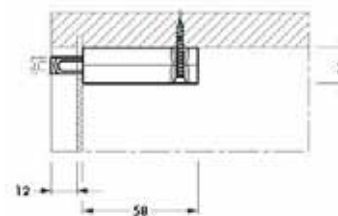
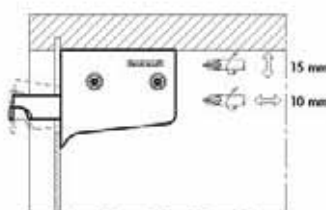
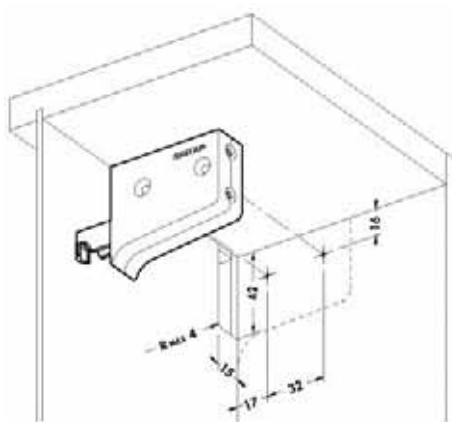
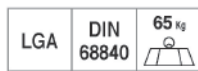
ΕΑΝ	ΚΩΔΙΚΟΣ		Μ.Μ.	
	132001.0002	λευκό	τεμ.	200



- ΛΑΜΑΚΙ ΣΤΗΡΙΞΗΣ ΑΝΑΡΤΗΡΩΝ ART.802

ΕΑΝ	ΚΩΔΙΚΟΣ		Μ.Μ.	
	132003.0001	νίκελ	τεμ.	1000

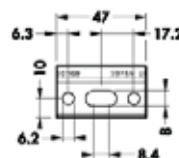



### 13.05 Αναρτήρες ντουλαπιών

#### ΑΝΑΡΤΗΡΑΣ ΚΡΥΦΟΣ CAMAR - ART.820

- ΑΝΑΡΤΗΡΑΣ ΚΡΥΦΟΣ ΜΕ DUBEL Φ10mm ART.820

LGA	DIN 68840	65 kg
-----	-----------	-------

ΕΑΝ	ΚΩΔΙΚΟΣ		Μ.Μ.	
	132001.0007 ΑΡΙΣΤΕΡΟ	νίκελ	τεμ.	200
	132001.0006 ΔΕΞΙ	νίκελ	τεμ.	200

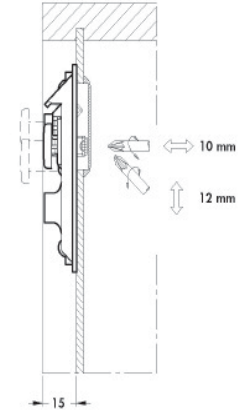
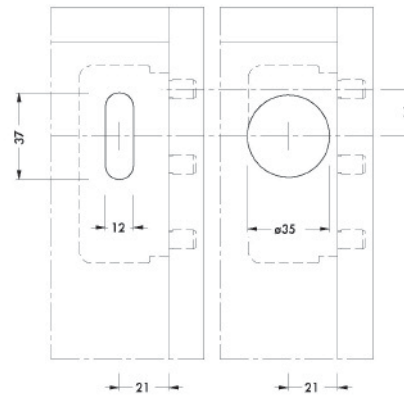
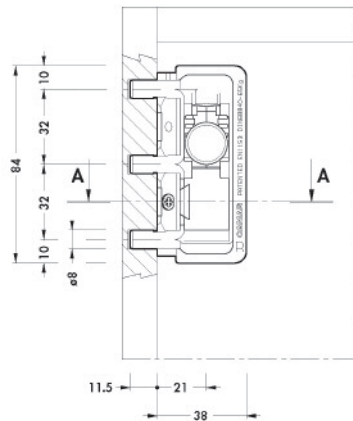
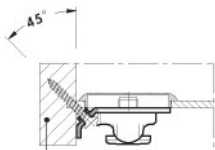

- ΛΑΜΑΚΙ ΣΤΗΡΙΞΗΣ ΑΝΑΡΤΗΡΩΝ ART.820

ΕΑΝ	ΚΩΔΙΚΟΣ		Μ.Μ.	
	132003.0001	νίκελ	τεμ.	1000

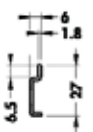
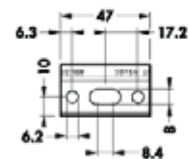

- ΤΑΓΙΑ Φ35mm ΑΝΑΡΤΗΡΑ ART.820

ΕΑΝ	ΚΩΔΙΚΟΣ		Μ.Μ.	
	132001.0005	λευκό	τεμ.	400

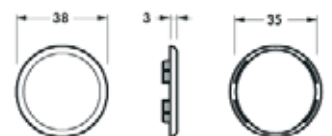

13.05 Αναρτήρες ντουλαπιών

ΑΝΑΡΤΗΡΑΣ ΚΡΥΦΟΣ CAMAR - ART.818

- ΑΝΑΡΤΗΡΑΣ ΚΡΥΦΟΣ ΜΕ DUBEL Φ8mm ART.818



ΕΑΝ	ΚΩΔΙΚΟΣ		Μ.Μ.	
	132001.0010 ΑΡΙΣΤΕΡΟ	νίκελ	τεμ.	100
	132001.0009 ΔΕΞΙ	νίκελ	τεμ.	100

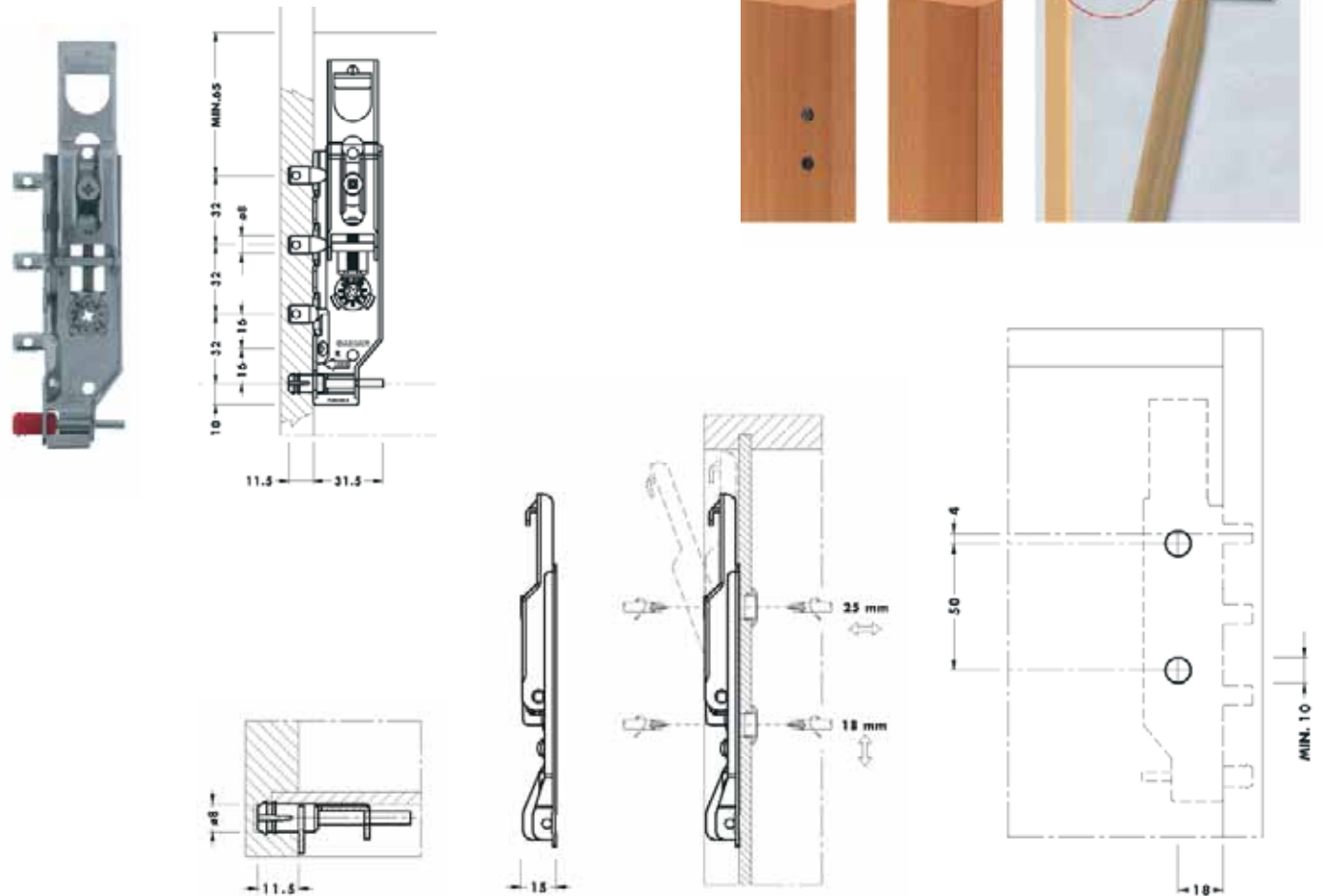

- ΛΑΜΑΚΙ ΣΤΗΡΙΞΗΣ ΑΝΑΡΤΗΡΩΝ ART.818

ΕΑΝ	ΚΩΔΙΚΟΣ		Μ.Μ.	
	132003.0001	νίκελ	τεμ.	1000

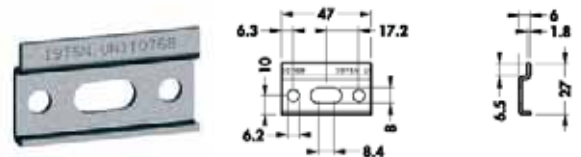

### 13.05 Αναρτήρες ντουλαπιών

#### ΑΝΑΡΤΗΡΑΣ ΚΡΥΦΟΣ CAMAR - ART.818

- ΤΑΠΕΣ Φ10mm ΑΝΑΡΤΗΡΑ ART.818

ΕΑΝ	ΚΩΔΙΚΟΣ		Μ.Μ.	
 5 205566 547289	132001.0011	λευκό	τεμ.	5000
 5 205566 547296	132001.0012	γκρι	τεμ.	5000

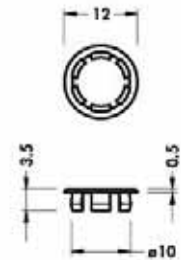

#### ΑΝΑΡΤΗΡΑΣ ΒΑΣΗΣ CAMAR - ART.807 (Για έπιπλα που δεν στηρίζονται σε ποδαράκια.)



## 13.05 Αναρτήρες ντουλαπιών



**ΑΝΑΡΤΗΡΑΣ ΒΑΣΗΣ CAMAR - ART.807** (Για έπιπλα που δεν στηρίζονται σε ποδαράκια.)

- ΑΝΑΡΤΗΡΑΣ ΒΑΣΗΣ ΜΕ 4 DUBEL Φ10mm ART.807

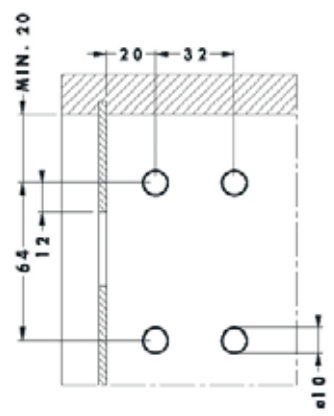
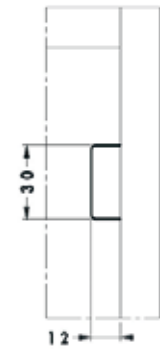
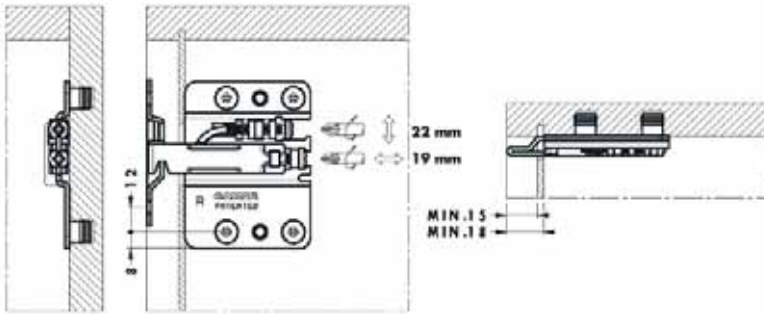
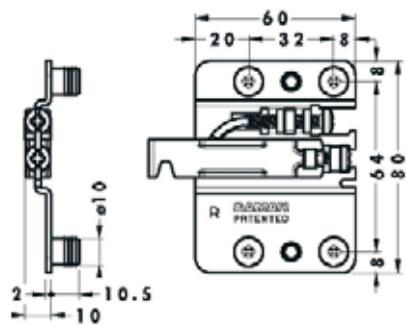
ΕΑΝ	ΚΩΔΙΚΟΣ		Μ.Μ.	
 5205566783632	132001.0017 ΑΡΙΣΤΕΡΟ	νίκελ	τεμ.	100
 5205566783588	132001.0016 ΔΕΞΙ	νίκελ	τεμ.	100



- ΛΑΜΑΚΙ ΣΤΗΡΙΞΗΣ ΑΝΑΡΤΗΡΩΝ ΒΑΣΗΣ ΜΕ ΕΛΑΤΗΡΙΟ ART.807

ΕΑΝ	ΚΩΔΙΚΟΣ		Μ.Μ.	
 5205566783649	132003.0003	νίκελ	τεμ.	100

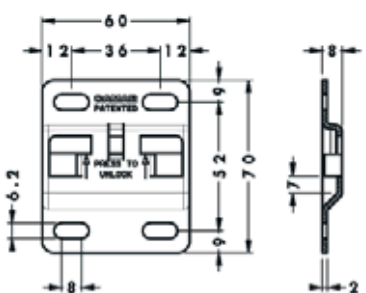
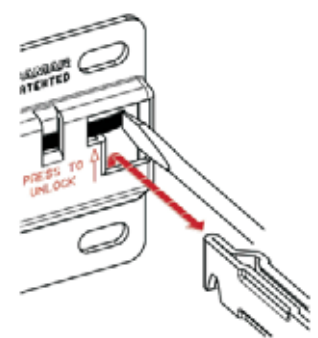



### 13.05 Αναρτήρες ντουλαπιών

**ΑΝΑΡΤΗΡΑΣ ΒΑΣΗΣ CAMAR - ART.807** (Για έπιπλα που δεν στηρίζονται σε ποδαράκια.)

- ΚΑΠΑΚΙΑ ΠΛΑΣΤΙΚΑ ΑΝΑΡΤΗΡΩΝ ART.807

ΕΑΝ	ΚΩΔΙΚΟΣ		Μ.Μ.	
	132002.0004 <b>ΑΡΙΣΤΕΡΟ</b>	λευκό	τεμ.	400
	132002.0003 <b>ΔΕΞΙ</b>	λευκό	τεμ.	400

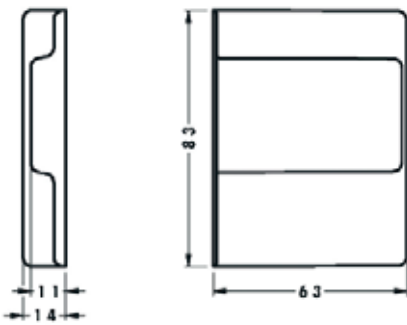

\* Το συνολικό πάχος του αναρτήρα με το καπάκι δεν εμποδίζει την χρήση οδηγών συρταριών.



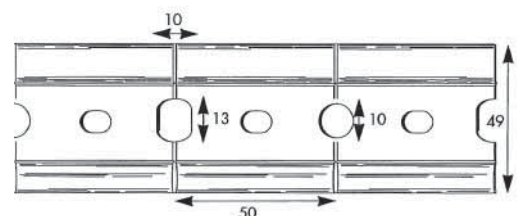
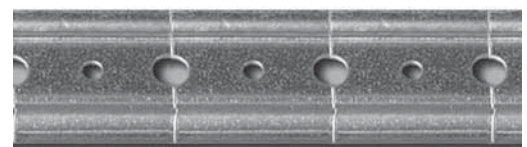

- ΜΠΑΡΑ ΑΝΑΡΤΗΣΗΣ 2000mm

ΕΑΝ	ΚΩΔΙΚΟΣ		Μ.Μ.	
	132004.0000	γαλβανιζέ μέτρο	20	



## 13.06 Κάδοι απορριμάτων

- ΚΑΔΟΣ ΠΛΑΣΤΙΚΟΣ ΜΕ ΜΗΧΑΝΙΣΜΟ

ΕΑΝ	ΚΩΔΙΚΟΣ	ΛΙΤΡΑ		Μ.Μ.	
 52055661207190	130101.0002	10	λευκό	τεμ.	4



- ΚΑΔΟΣ ΙΝΟΧ ΜΕ ΜΗΧΑΝΙΣΜΟ

ΕΑΝ	ΚΩΔΙΚΟΣ	ΛΙΤΡΑ		Μ.Μ.	
 52055661192557	130103.0002	10	inox	τεμ.	1

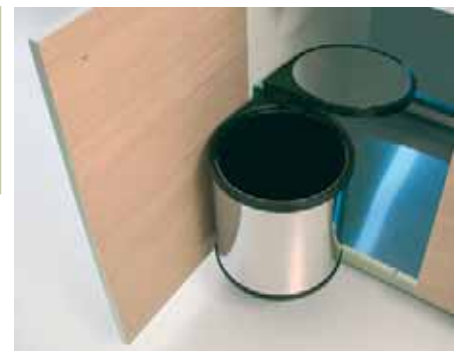



### 13.07 Μηχανισμοί κουζίνας



- ΜΗΧΑΝΙΣΜΟΣ "MAGIC CORNER DIAMOND" ΜΕ ΦΡΕΝΟ, ΓΙΑ ΚΟΥΤΙ 900mm

EAN	ΚΩΔΙΚΟΣ		M.M.	
	130413.0006 αριστερό άνοιγμα	χρώμιο	τεμ.	1
	130413.0007 δεξί άνοιγμα	χρώμιο	τεμ.	1

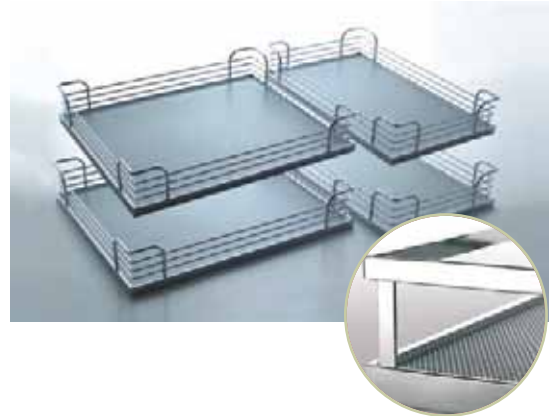

Αντοχή: 6kg τα μεγάλα καλάθια & 5kg τα μικρά

- ΜΗΧΑΝΙΣΜΟΣ "MAGIC CORNER MFC" ΜΕ ΦΡΕΝΟ, ΓΙΑ ΚΟΥΤΙ 900mm

EAN	ΚΩΔΙΚΟΣ		M.M.	
	130413.0004 αριστερό άνοιγμα	χρώμιο	τεμ.	1
	130413.0005 δεξί άνοιγμα	χρώμιο	τεμ.	1



Αντοχή: 6kg τα μεγάλα καλάθια & 5kg τα μικρά

- ΜΗΧΑΝΙΣΜΟΣ "MAGIC CORNER " ΜΕ ΦΡΕΝΟ, ΓΙΑ ΚΟΥΤΙ 900mm

EAN	ΚΩΔΙΚΟΣ		M.M.	
	130413.0002 αριστερό άνοιγμα	χρώμιο	τεμ.	1
	130413.0003 δεξί άνοιγμα	χρώμιο	τεμ.	1





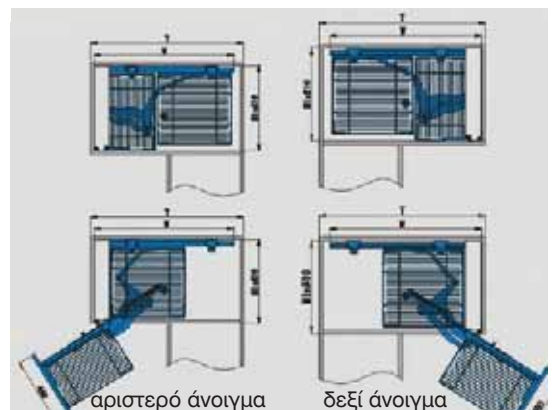

Αντοχή: 6kg τα μεγάλα καλάθια & 5kg τα μικρά

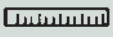

## 13.07 Μηχανισμοί κουζίνας





- ΜΗΧΑΝΙΣΜΟΣ "HAND CORNER MFC" ΜΕ ΦΡΕΝΟ, ΓΙΑ ΚΟΥΤΙ 800mm

ΕΑΝ	ΚΩΔΙΚΟΣ			Μ.Μ.	
 512055661354191	130413.0012	660 x 515 x 600 mm	χρώμιο	τεμ.	1

Αντοχή: 6kg το καλάθι



- ΜΗΧΑΝΙΣΜΟΣ "HAND CORNER" ΜΕ ΦΡΕΝΟ, ΓΙΑ ΚΟΥΤΙ 800mm

ΕΑΝ	ΚΩΔΙΚΟΣ			Μ.Μ.	
 512055661354429	130413.0013	660 x 515 x 600 mm	χρώμιο	τεμ.	1

Αντοχή: 6kg το καλάθι





13.07 Μηχανισμοί κουζίνας



- ΜΗΧΑΝΙΣΜΟΣ "SWING TRAY DIAMOND" ΜΕ ΦΡΕΝΟ, ΓΙΑ ΚΟΥΤΙ 900mm

ΕΑΝ	ΚΩΔΙΚΟΣ		Μ.Μ.	
	130413.0010 αριστερό άνοιγμα	χρώμιο	τεμ.	1
	130413.0011 δεξί άνοιγμα	χρώμιο	τεμ.	1



Αντοχή: 10kg το κάθε καλάθι

- ΜΗΧΑΝΙΣΜΟΣ "SWING TRAY MFC" ΜΕ ΦΡΕΝΟ, ΓΙΑ ΚΟΥΤΙ 900mm

ΕΑΝ	ΚΩΔΙΚΟΣ		Μ.Μ.	
	130413.0008 αριστερό άνοιγμα	χρώμιο	τεμ.	1
	130413.0009 δεξί άνοιγμα	χρώμιο	τεμ.	1



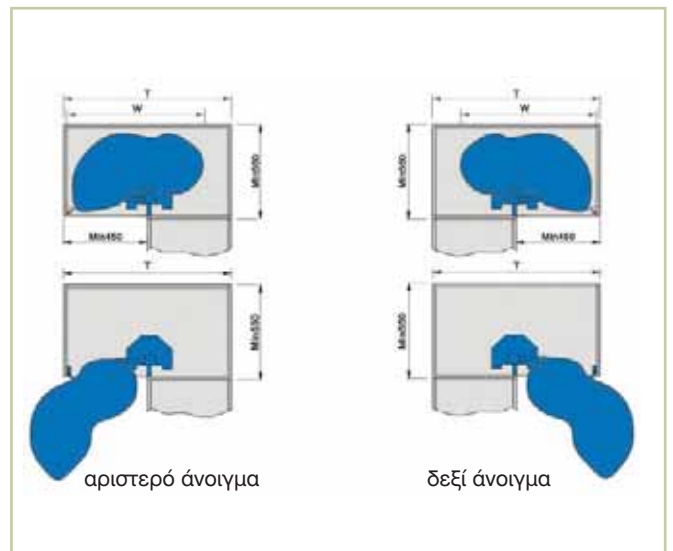

Αντοχή: 10kg το κάθε καλάθι



## 13.07 Μηχανισμοί κουζίνας





- ΜΗΧΑΝΙΣΜΟΣ "HAND CORNER MFC" ΜΕ ΦΡΕΝΟ

ΕΑΝ	ΚΩΔΙΚΟΣ			Μ.Μ.	
	130505.0009	για κουτί 400 mm	χρώμιο	τεμ.	4
	130505.0010	για κουτί 450 mm	χρώμιο	τεμ.	4
	130505.0011	για κουτί 500 mm	χρώμιο	τεμ.	4
	130505.0012	για κουτί 600 mm	χρώμιο	τεμ.	4



Αντοχή: 30kg το καλάθι

- ΣΤΗΡΙΓΜΑ ΜΕΤΩΠΗΣ ΣΥΡΤΑΡΙΟΥ

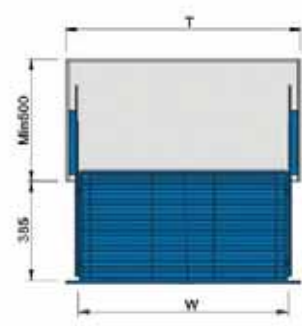
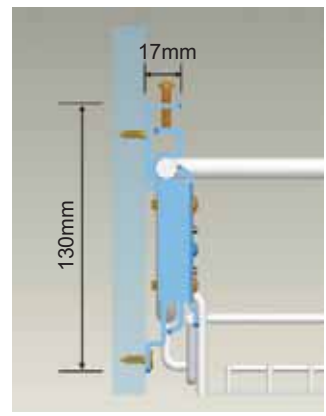

ΕΑΝ	ΚΩΔΙΚΟΣ			Μ.Μ.	
	130505.0013	-	χρώμιο	τεμ.	1





### 13.08 Μηχανισμοί τραπεζιών κουζίνας

- ΜΗΧΑΝΙΣΜΟΣ ΤΡΑΠΕΖΙΟΥ ADAR ART.230 ΜΕ ΣΠΑΣΤΗ ΜΕΤΩΠΗ

ΕΑΝ	ΚΩΔΙΚΟΣ	ΒΑΘΟΣ ΚΟΥΤΙΟΥ	ΒΑΘΟΣ ΕΠΙΦΑΝΕΙΑΣ	ΑΝΟΙΓΜΑ	Μ.Μ.	
	120124.0001	PB min: 440mm	LP min: 335mm	PULL OUT: 644mm	σετ	1
	120124.0002	PB min: 530mm	LP min: 420mm	PULL OUT: 814mm	σετ	1

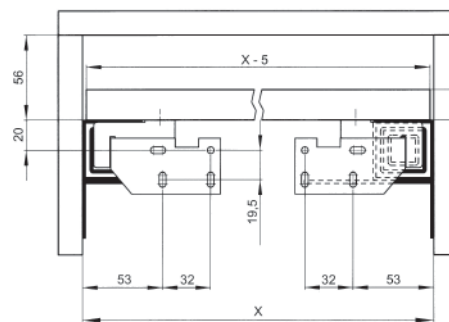

- Τοποθετήστε τους τηλεσκοπικούς οδηγούς στα πλαϊνά του κουτιού, τηρώντας τις απαιτούμενες διαστάσεις.
- Με κλειστούς τους τηλεσκοπικούς οδηγούς, ενώστε τη μετώπη με το σύνδεσμο Η. Αν χρειάζεται, ρυθμίστε τη μετώπη σε ύψος και πλάτος, χαλαρώνοντας τις αντίστοιχες βίδες και μετά ξανασφίξτε.

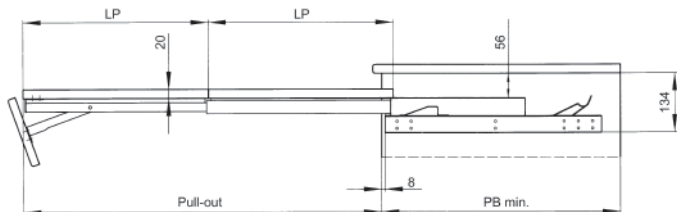

1. Κάντε δύο τρύπες  $\Phi 7 \times 15 \text{mm}$  στην επιφάνεια Α.



2. Τοποθετήστε τις βέργες.



3. Τοποθετείστε τα εξαρτήματα όπως φαίνονται στις παραπάνω εικόνες.



4. Τοποθετείστε τα εξαρτήματα όπως φαίνονται στις παραπάνω εικόνες.







5. Γυρίστε τις επιφάνειες από την άλλη πλευρά και τοποθετείστε τις επάνω στους οδηγούς του κουτιού. Συνδέστε την εξωτερική επιφάνεια Β με τον σύνδεσμο Γ, όπως φαίνεται στο διπλανό σκίτσο αριστερά.

6. Ανοίξτε εντελώς τη συρόμενη επιφάνεια και ξανακλείστε την, επιβεβαιώνοντας ότι η εσωτερική επιφάνεια Α, όταν ξαναμπαιίνει, ανεβαίνει πάνω στο βιδωμένο τμήμα του οδηγού και ότι η εξωτερική επιφάνεια Β περνάει κάτω από την Α. Επίσης ελέγξτε αν η Β τραβά σωστά την Α προς τα έξω. Αν αυτό δε συμβαίνει, το εξάρτημα Ε χρειάζεται ρύθμιση.

13.08 Μηχανισμοί τραπεζιών κουζίνας





- ΜΗΧΑΝΙΣΜΟΣ ΤΡΑΠΕΖΙΟΥ ΣΥΡΟΜΕΝΟΣ ΡΟΛΛ ΤΟΠ

ΕΑΝ	ΚΩΔΙΚΟΣ			Μ.Μ.	
 5 205566 1185054	120201.0000	750mm	γαλβανιζέ	σετ	1





13.09 Σωλήνας ντουλάπας

- ΣΩΛΗΝΑΣ ΟΒΑΛ 30x15mm

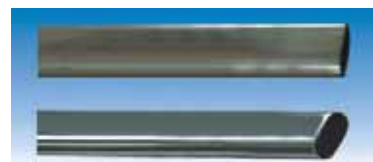
ΕΑΝ	ΚΩΔΙΚΟΣ			Μ.Μ.	
 5 205566 1288632	131602.0006	2950mm	χρώμιο	βέργα	10



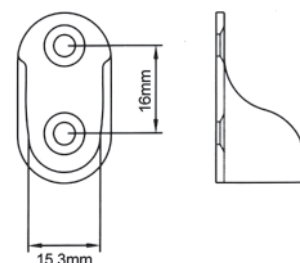

- ΣΤΗΡΙΓΜΑ ΣΩΛΗΝΑ ΟΒΑΛ ΜΕ 2 ΥΠΟΔΟΧΕΣ

ΕΑΝ	ΚΩΔΙΚΟΣ		Μ.Μ.	
 5 205566 1443864	160305.0002	νίκελ	τεμ.	1500



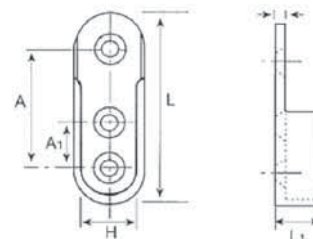

- ΣΤΗΡΙΓΜΑ ΣΩΛΗΝΑ ΟΒΑΛ ΜΕ 3 ΟΠΕΣ

ΕΑΝ	ΚΩΔΙΚΟΣ		Μ.Μ.	
 5 205566 1293209	160305.0004	νίκελ	τεμ.	1



- ΣΤΗΡΙΓΜΑ ΣΩΛΗΝΑ ΟΒΑΛ, ΓΩΝΙΑΚΟ

ΕΑΝ	ΚΩΔΙΚΟΣ		Μ.Μ.	
 5 205566 1036097	160301.0002	zamak	τεμ.	250

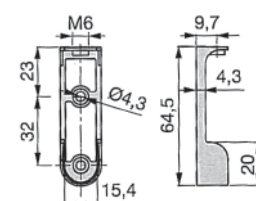





 13.10 Servetto - Οργάνωση ρουχισμού



## 13.10 Servetto - Οργάνωση ρουχισμού

- ΛΣΑΝΣΕΡ ΝΤΟΥΛΑΠΑΣ SERVETTO SE 2004

ΕΑΝ	ΚΩΔΙΚΟΣ			 kg	Μ.Μ	
	131807.0008*	440-610mm	μαύρο	10	τεμ.	6
	131807.0009*	440-610mm	νίκελ	10	τεμ.	6
	131807.0011*	440-610mm	αλουμίνιο	10	τεμ.	6
	131807.0010*	440-610mm	λευκό	10	τεμ.	6
	131807.0012	600-1000mm	μαύρο	10	τεμ.	6
	131807.0013	600-1000mm	νίκελ	10	τεμ.	6
	131807.0018*	600-1000mm	αλουμίνιο	10	τεμ.	6
	131807.0019*	600-1000mm	λευκό	10	τεμ.	6
	131807.0002	770-1200mm	μαύρο	10	τεμ.	6
	131807.0000	770-1200mm	νίκελ	10	τεμ.	6
	131807.0016*	770-1200mm	αλουμίνιο	10	τεμ.	6
	131807.0017*	770-1200mm	λευκό	10	τεμ.	6

\* κατόπιν παραγγελίας

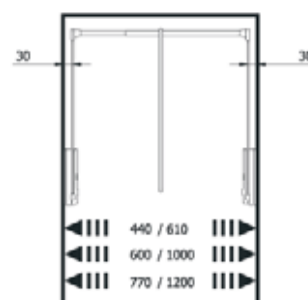
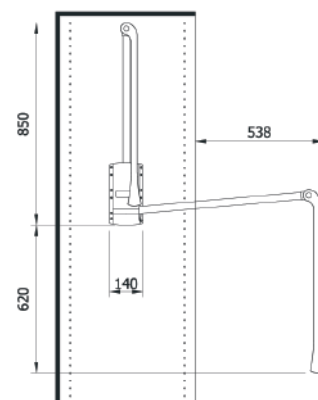

### 13.10 Servetto - Οργάνωση ρουχισμού

- ΑΠΟΣΤΑΤΗΣ ΑΣΑΝΣΕΡ ΝΤΟΥΛΑΠΑΣ SERVETTO SE 2004

ΕΑΝ	ΚΩΔΙΚΟΣ		Μ.Μ.	
	131909.0007	μαύρο	ζεύγος	1
	131909.0020*	γκρι	ζεύγος	1

Σε περίπτωση όπου μεντεσέδες ή πόρτες εμποδίζουν το κατέβασμα του ασανσέρ **SERVETTO** συνιστούμε την τοποθέτηση του, με την χρήση ενός ή δύο τεμαχίων αποστατών ανά βραχίονα.

\* κατόπιν παραγγελίας



- ΑΣΑΝΣΕΡ ΝΤΟΥΛΑΠΑΣ ΣΕ ONLY, ΔΙΠΛΟ

ΕΑΝ	ΚΩΔΙΚΟΣ				Μ.Μ.	
	131804.0000*	730-1190mm	μπεζ	12	τεμ.	4

\* κατόπιν παραγγελίας



- ΑΣΑΝΣΕΡ ΝΤΟΥΛΑΠΑΣ ΣΕ ONLY, ΜΟΝΟ





ΕΑΝ	ΚΩΔΙΚΟΣ				Μ.Μ.	
	131804.0001*	457-660mm	μπεζ	5,5	τεμ.	8

\* κατόπιν παραγγελίας

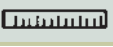

## 13.10 Servetto - Οργάνωση ρουχισμού

- ΑΣΑΝΣΕΡ ΟΤΤΟ CLOSET PRO ΓΙΑ ΣΤΗΡΙΞΗ ΣΕ ΤΟΙΧΟ





ΕΑΝ	ΚΩΔΙΚΟΣ				Μ.Μ.	
 52055661248254	131913.0001*	650-1150mm	γκρι αλουμίνιο	10	τεμ.	6



\* κατόπιν παραγγελίας



- ΑΣΑΝΣΕΡ ΟΤΤΟ CLOSET PRO ΓΙΑ ΣΤΗΡΙΞΗ ΣΕ ΤΟΙΧΟ

ΕΑΝ	ΚΩΔΙΚΟΣ				Μ.Μ.	
 52055661249336	131913.0000*	620-950mm	γκρι αλουμίνιο	8	τεμ.	6



\* κατόπιν παραγγελίας



### 13.10 Servetto - Οργάνωση ρουχισμού

- ΡΑΦΙ ΠΑΠΟΥΤΣΙΩΝ "ΣΕ ΤΑC"

ΕΑΝ	ΚΩΔΙΚΟΣ		Μ.Μ.	
	131904.0000	μαύρο	τεμ.	10

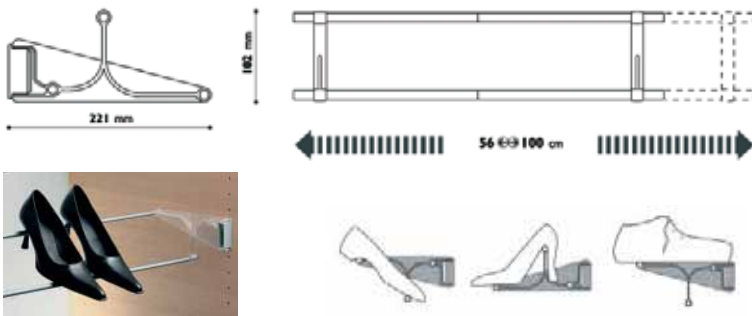

- ΒΡΑΧΙΟΝΕΣ FINALLY ΓΙΑ ΓΥΑΛΙΝΟ ΡΑΦΙ

ΕΑΝ	ΚΩΔΙΚΟΣ		Μ.Μ.	
	131913.0005*	γκρι	ζεύγος	4

\* κατόπιν παραγγελίας

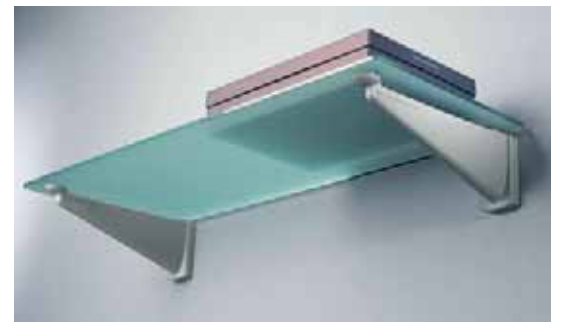

- ΒΡΑΧΙΟΝΑΣ FINALLY ΓΙΑ ΣΥΡΟΜΕΝΑ ΕΞΑΡΤΗΜΑΤΑ

ΕΑΝ	ΚΩΔΙΚΟΣ		Μ.Μ.	
	131913.0007*	γκρι	τεμ.	5

\* κατόπιν παραγγελίας

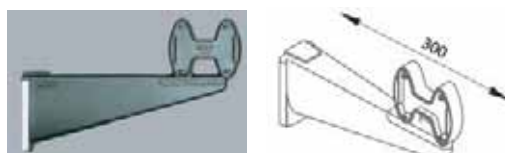

## 13.10 Servetto - Οργάνωση ρουχισμού

### • ΓΡΑΒΑΤΟΘΗΚΗ ΣΥΡΟΜΕΝΗ 32 ΘΕΣΕΩΝ

ΕΑΝ	ΚΩΔΙΚΟΣ		Μ.Μ.	
 5205566198153	131901.0000	μαύρο αλουμίνιο	τεμ.	12
 5205566184866	139903.0003*	μπεζ αλουμίνιο	τεμ.	12
 5205566248339	131901.0006*	διάφανο αλουμίνιο	τεμ.	12

\* κατόπιν παραγγελίας

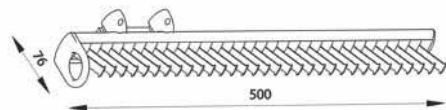

### • ΓΡΑΒΑΤΟΘΗΚΗ ΣΤΑΘΕΡΗ 28 ΘΕΣΕΩΝ

ΕΑΝ	ΚΩΔΙΚΟΣ		Μ.Μ.	
 5205566198160	131901.0001	μαύρο αλουμίνιο	τεμ.	20
 5205566184873	139903.0004*	μπεζ αλουμίνιο	τεμ.	20
 52055661351923	139903.0026*	διάφανο αλουμίνιο	τεμ.	20

\* κατόπιν παραγγελίας

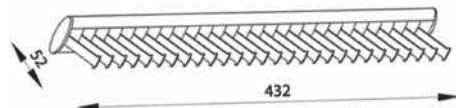

### • ΓΡΑΒΑΤΟΘΗΚΗ ΣΥΡΟΜΕΝΗ 20 ΘΕΣΕΩΝ, ΜΕ ΘΗΚΗ

ΕΑΝ	ΚΩΔΙΚΟΣ		Μ.Μ.	
 5205566261598	131901.0002*	μαύρο αλουμίνιο	τεμ.	6
 5205566198238	131901.0003*	μπεζ αλουμίνιο	τεμ.	6
 5205566466980	131901.0010*	διάφανο αλουμίνιο	τεμ.	6



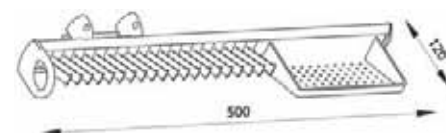

\* κατόπιν παραγγελίας





### 13.10 Servetto - Οργάνωση ρουχισμού



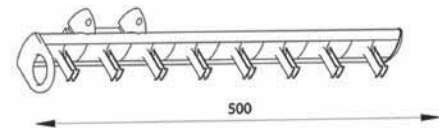

- ΘΗΚΗ ΓΙΑ ΖΩΝΕΣ ΣΥΡΟΜΕΝΗ 8 ΘΕΣΕΩΝ

ΕΑΝ	ΚΩΔΙΚΟΣ		Μ.Μ.	
 5 205566 198375	131911.0000	μαύρο αλουμίνιο	τεμ.	12
 5 205566 1248889	131911.0002*	διάφανο αλουμίνιο	τεμ.	12

\* κατόπιν παραγγελίας





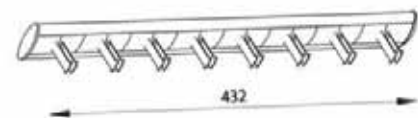

- ΘΗΚΗ ΓΙΑ ΖΩΝΕΣ ΣΤΑΘΕΡΗ 7 ΘΕΣΕΩΝ

ΕΑΝ	ΚΩΔΙΚΟΣ		Μ.Μ.	
 5 205566 198382	131911.0001*	μαύρο αλουμίνιο	τεμ.	20
 5 205566 1351954	131911.0003*	διάφανο αλουμίνιο	τεμ.	20

\* κατόπιν παραγγελίας



- ΘΗΚΗ ΓΙΑ ΦΟΥΛΑΡΙΑ ΣΤΑΘΕΡΗ 8 ΘΕΣΕΩΝ

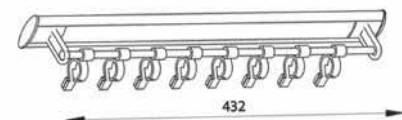

ΕΑΝ	ΚΩΔΙΚΟΣ		Μ.Μ.	
 5 205566 1261611	131910.0001*	μαύρο αλουμίνιο	τεμ.	20
 5 205566 1351978	131910.0002*	διάφανο αλουμίνιο	τεμ.	20

\* κατόπιν παραγγελίας



13.10 Servetto - Οργάνωση ρουχισμού



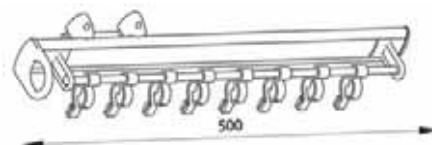

- ΘΗΚΗ ΓΙΑ ΦΟΥΛΑΡΙΑ ΣΥΡΟΜΕΝΗ 8 ΘΕΣΕΩΝ

ΕΑΝ	ΚΩΔΙΚΟΣ		Μ.Μ.	
 52055661198368	131910.0000*	μαύρο αλουμίνιο	τεμ.	12

\* κατόπιν παραγγελίας



- ΘΗΚΗ ΣΥΡΟΜΕΝΗ ΚΑΙ ΣΠΑΣΤΗ

ΕΑΝ	ΚΩΔΙΚΟΣ		Μ.Μ.	
 52055661261864	131901.0004*	μαύρο αλουμίνιο	τεμ.	3
 52055661248346	131901.0007*	διάφανο αλουμίνιο	τεμ.	3

\* κατόπιν παραγγελίας

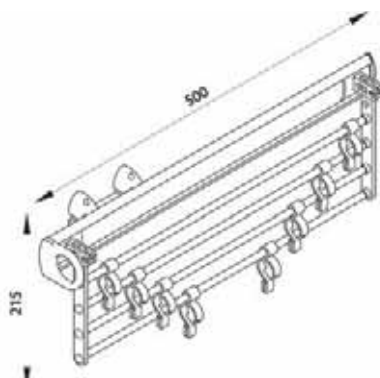

- ΒΑΣΗ ΣΤΗΡΙΞΗΣ ΓΙΑ ΡΑΦΙ

ΕΑΝ	ΚΩΔΙΚΟΣ		Μ.Μ.	
 52055661261604	131909.0000*	μαύρο	τεμ.	24
 52055661198283	131909.0001*	μπεζ	τεμ.	24
 52055661248896	131909.0010*	διάφανο	τεμ.	24

\* κατόπιν παραγγελίας







### 13.10 Servetto - Οργάνωση ρουχισμού

- ΑΠΟΣΤΑΤΗΣ ΓΙΑ ΣΥΡΟΜΕΝΑ ΕΞΑΡΤΗΜΑΤΑ

ΕΑΝ	ΚΩΔΙΚΟΣ		Μ.Μ.	
	131909.0002*	μαύρο	ζεύγος	1
	131909.0003*	μπεζ	ζεύγος	1

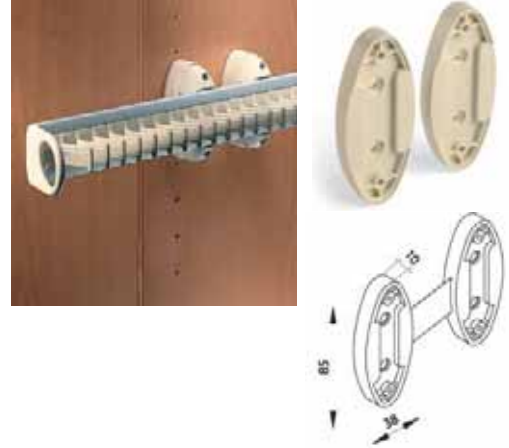

Χρησιμοποιούνται σε περίπτωση όπου μεντεσέδες ή πόρτες εμποδίζουν τα συρόμενα εξαρτήματα στην κίνησή τους.

\* κατόπιν παραγγελίας

- ΘΗΚΗ- ΣΥΡΤΑΡΙ ΤΗΛΕΣΚΟΠΙΚΗ ΣΥΡΟΜΕΝΗ

ΕΑΝ	ΚΩΔΙΚΟΣ		Μ.Μ.	
	139903.0028*	γκρι αλουμίνιο	τεμ.	1

\* κατόπιν παραγγελίας

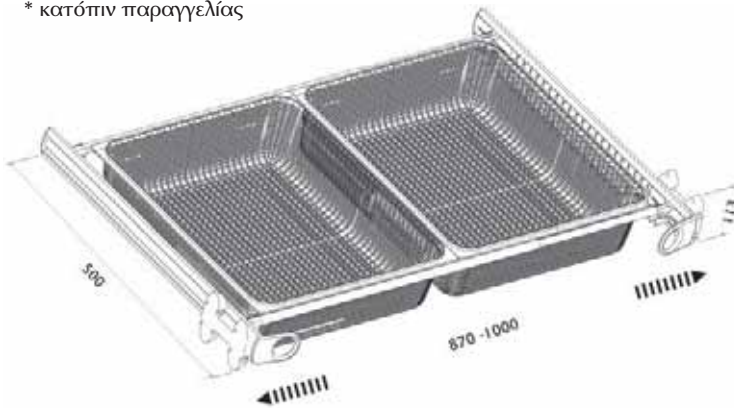
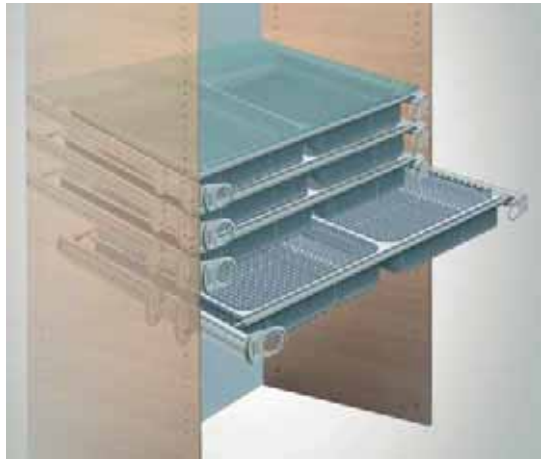

- ΘΗΚΗ ΓΙΑ ΠΑΝΤΕΛΟΝΙΑ ΤΗΛΕΣΚΟΠΙΚΗ ΣΥΡΟΜΕΝΗ



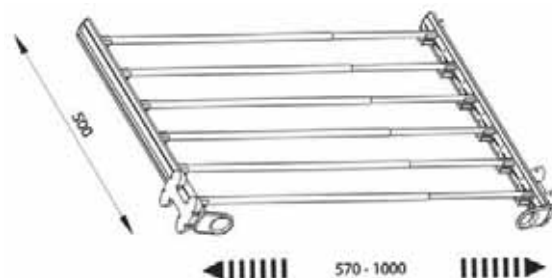

ΕΑΝ	ΚΩΔΙΚΟΣ		Μ.Μ.	
	139903.0027*	αλουμίνιο διάφανο	τεμ.	6

\* κατόπιν παραγγελίας



## 13.10 Servetto - Οργάνωση ρουχισμού Σειρά "DESIGN"



- ΚΡΕΜΑΣΤΡΑ DINO 420mm

ΕΑΝ	ΚΩΔΙΚΟΣ		Μ.Μ.	
	131905.0001*	πορτοκαλί	τεμ.	3
	131905.0002*	μαύρο	τεμ.	3



\* κατόπιν παραγγελίας

- ΒΡΑΧΙΟΝΕΣ FINALLY ΜΕ ΣΩΛΗΝΑ

ΕΑΝ	ΚΩΔΙΚΟΣ		Μ.Μ.	
	131913.0003*	γκρι αλουμίνιο	σετ	1



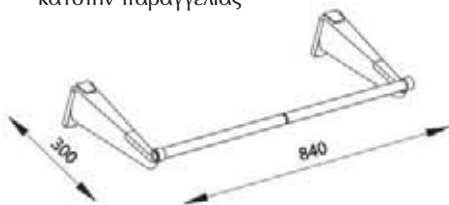

Το σετ δεν περιλαμβάνει τις κρεμάστρες.

\* κατόπιν παραγγελίας



- ΚΑΛΟΓΕΡΟΣ ΡΟΥΧΩΝ "ΒΟΒΟ"

ΕΑΝ	ΚΩΔΙΚΟΣ		Μ.Μ.	
	131915.0003*	πορτοκαλί	τεμ.	1

\* κατόπιν παραγγελίας





### 13.10 Servetto - Οργάνωση ρουχισμού Σειρά "DESIGN"

● ΚΑΛΟΓΕΡΟΣ ΡΟΥΧΩΝ "PISOLO"

ΕΑΝ	ΚΩΔΙΚΟΣ		Μ.Μ.	
 52055664500956	131915.0024*	λευκό	τεμ.	1
 52055664351862	131915.0004*	πορτοκαλί	τεμ.	1

\* κατόπιν παραγγελίας



● ΚΑΛΟΓΕΡΟΣ ΡΟΥΧΩΝ "ΚΑΛΙΜΕΡΑ"

ΕΑΝ	ΚΩΔΙΚΟΣ		Μ.Μ.	
 52055664351831	131915.0002*	πορτοκαλί	τεμ.	1

\* κατόπιν παραγγελίας



● ΚΑΛΟΓΕΡΟΣ ΡΟΥΧΩΝ "TULIPAN"



ΕΑΝ	ΚΩΔΙΚΟΣ		Μ.Μ.	
 5205566492633	131915.0007*	λευκό	τεμ.	1
 5205566493326	131915.0009*	φούξια	τεμ.	1
 5205566493340	131915.0011*	μαύρο	τεμ.	1
 5205566492640	131915.0008*	πορτοκαλί	τεμ.	1
 5205566493333	131915.0010*	γκρι	τεμ.	1

\* κατόπιν παραγγελίας



13.10 Servetto - Οργάνωση ρουχισμού  
Σειρά "DESIGN"

- ΟΜΠΡΕΛΟΘΗΚΗ "BLITZ"

ΕΑΝ	ΚΩΔΙΚΟΣ		Μ.Μ.	
 52055661564644	131915.0028*	γκρι	τεμ.	1



\* κατόπιν παραγγελίας



- ΚΑΛΟΓΕΡΟΣ ΡΟΥΧΩΝ "SCACCO MATTO"

ΕΑΝ	ΚΩΔΙΚΟΣ		Μ.Μ.	
 52055661799985	131915.0041*	λευκό	τεμ.	1
 52055661799992	131915.0042*	πορτοκαλί	τεμ.	1
 52055661800001	131915.0043*	γκρι	τεμ.	1
 52055661800018	131915.0044*	μαύρο	τεμ.	1

\* κατόπιν παραγγελίας



- ΚΑΘΡΕΦΤΗΣ ΔΑΠΕΔΟΥ "CENERENTOLA"

ΕΑΝ	ΚΩΔΙΚΟΣ		Μ.Μ.	
 52055661493418	131915.0016*	γκρι	τεμ.	1
 52055661493395	131915.0014*	λευκό	τεμ.	1
 52055661564620	131915.0027*	πορτοκαλί	τεμ.	1

\* κατόπιν παραγγελίας





 13.11 Φωτισμός



## 13.11 Φωτισμός

- ΣΠΟΤ "MIDI BK" 20W 12V



ΕΑΝ	ΚΩΔΙΚΟΣ		Μ.Μ.	
	131704.0001	αλουμίνιο	τεμ.	50
	131704.0004	νίκελ	τεμ.	100
	131704.0003	χρώμιο	τεμ.	50
	131704.0002	χρυσασφί	τεμ.	50

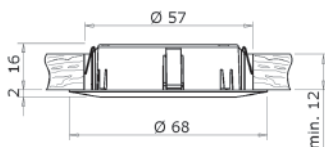

\* Για τη λειτουργία του σποτ MIDI BK χρειάζεται ο μετασχηματιστής **ECO60 60W** Κωδ.: 131704.0017



- ΣΠΟΤ "SATURNO" 20W 12V

ΕΑΝ	ΚΩΔΙΚΟΣ		Μ.Μ.	
	131704.0005	αλουμίνιο	τεμ.	20

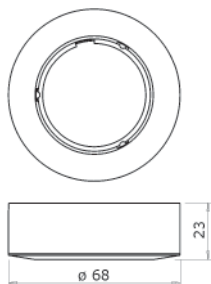

\* Για τη λειτουργία του σποτ "SATURNO" χρειάζεται ο μετασχηματιστής **MD80 80W** Κωδ.: 131704.0015





### 13.11 Φωτισμός

- ΣΠΟΤ "SATURNO OB" 20W 12V

ΕΑΝ	ΚΩΔΙΚΟΣ		Μ.Μ.	
 52055664060832	131704.0006	αλουμίνιο	τεμ.	10

\* Για τη λειτουργία του σποτ "SATURNO OB" χρειάζεται ο μετασχηματιστής MD80 80W Κωδ.: 131704.0015

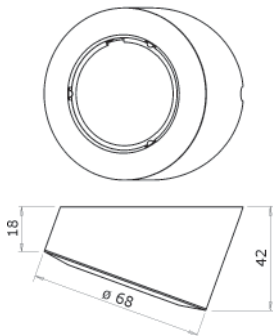

- ΣΠΟΤ ΤΡΙΓΩΝΙΚΟ "PIRAMIDE"

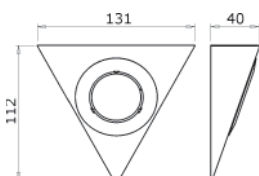

ΕΑΝ	ΚΩΔΙΚΟΣ		Μ.Μ.	
 52055664060863	131704.0009 20W 12V	αλουμίνιο	τεμ.	40
 52055664070381	131704.0010 20W 12V	μεταλλικό	τεμ.	40
 52055664060849	131704.0007 IG 3x20W 12V	αλουμίνιο	σετ	10
 52055664060856	131704.0008 IG 3x20W 12V	μεταλλικό	σετ	20

\* Για τη λειτουργία του σποτ "PIRAMIDE" χρειάζεται ο μετασχηματιστής MD80 80W Κωδ.: 131704.0015 ή Touch Dimmer TD70 70W 131704.0018



## 13.11 Φωτισμός



- ΣΠΟΤ "FREE LIGHT LWT2" 20W 12V

ΕΑΝ	ΚΩΔΙΚΟΣ		Μ.Μ.	
 52055664076963	131704.0013	μεταλλικό	τεμ.	40

\* Ο μετασχηματιστής περιλαμβάνεται στη συσκευασία.





- ΣΠΟΤ "FREE LIGHT LW1" 20W 12V

ΕΑΝ	ΚΩΔΙΚΟΣ		Μ.Μ.	
 52055664060887	131704.0012	μεταλλικό	τεμ.	50

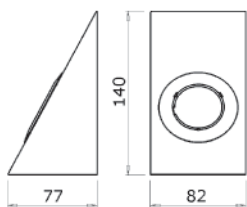
\* Για τη λειτουργία του σποτ "FREE LIGHT LW1" χρειάζεται ο μετασχηματιστής MD80 80W Κωδ.: 131704.0015 ή Touch Dimmer TD70 70W 131704.0018



- ΣΠΟΤ "EVOSLIDE"

ΕΑΝ	ΚΩΔΙΚΟΣ		Μ.Μ.	
 52055664767984	131704.0050 1LED 1.2W	αλουμίνιο	τεμ.	-

\* Για τη λειτουργία του σποτ "EVOSLIDE" χρειάζεται ο μετασχηματιστής NANO 6W Κωδ.: 131704.0051, HUB 15W 131704.0052





### 13.11 Φωτισμός

- ΠΛΑΦΟΝΙΕΡΑ ΜΕΤΑΛΛΙΚΗ "ISY"

ΕΑΝ	ΚΩΔΙΚΟΣ			Μ.Μ.	
	131704.0037 ΜΕ 2 ΣΠΟΤ 2x20W	450mm	αλουμίνιο	τεμ.	10
	131704.0038 ΜΕ 2 ΣΠΟΤ 2x20W	600mm	αλουμίνιο	τεμ.	10
	131704.0039 ΜΕ 3 ΣΠΟΤ 3x20W	900mm	αλουμίνιο	τεμ.	10



\* Έχουν ενσωματωμένο μετασχηματιστή.

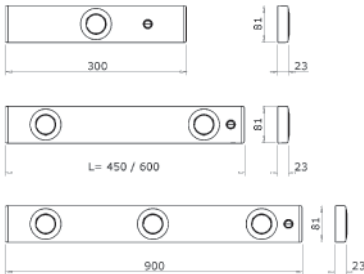

- ΠΡΙΖΑ SCHUKO "ISY"

ΕΑΝ	ΚΩΔΙΚΟΣ			Μ.Μ.	
	131704.0040 16A 250V	150mm	αλουμίνιο	τεμ.	20



- ΦΩΤΙΣΤΙΚΟ "MODUS CR"

ΕΑΝ	ΚΩΔΙΚΟΣ			Μ.Μ.	
	131704.0048 3LED 3.6W	600mm	αλουμίνιο	τεμ.	20
	131704.0049 4LED 4.8W	900mm	αλουμίνιο	τεμ.	20



\* Για τη λειτουργία του "MODUS CR" απαιτείται η χρήση των μετασχηματιστών:  
 NANO 6W Κωδ.: 131704.0051, HUB 15W 131704.0052

## 13.11 Φωτισμός

- ΦΩΤΙΣΤΙΚΟ ΣΩΛΗΝΑ ΚΡΕΜΑΣΤΟ "PLAY" 230V

ΕΑΝ	ΚΩΔΙΚΟΣ			Μ.Μ.	
	131704.0024 8W 230V	580mm	αλουμίνιο	τεμ.	10
	131704.0025 8W 230V	860mm	αλουμίνιο	τεμ.	10

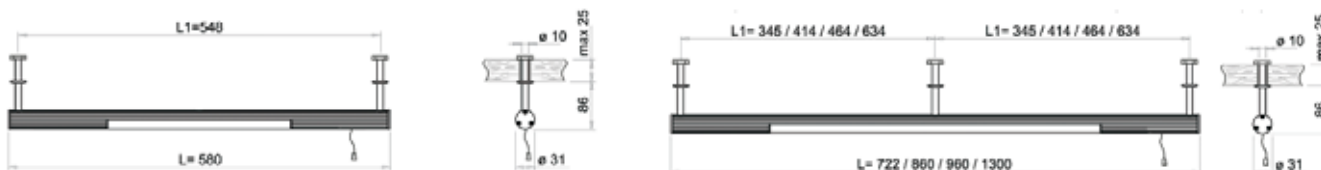

- ΡΑΦΙ ΦΩΤΙΖΟΜΕΝΟ "ΑΝΘΕΑ" 230V

ΕΑΝ	ΚΩΔΙΚΟΣ			Μ.Μ.	
	131704.0032 8W 230V	450mm	αλουμίνιο	τεμ.	5
	131704.0033 14W 230V	600mm	αλουμίνιο	τεμ.	5
	131704.0034 21W 230V	900mm	αλουμίνιο	τεμ.	5
	131704.0031 28W 230V	1200mm	αλουμίνιο	τεμ.	5

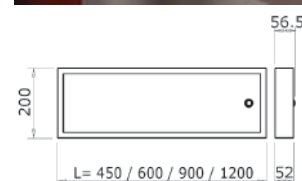

- ΠΑΤΟΣ ΚΟΥΤΙΟΥ ΚΟΥΖΙΝΑΣ ΦΩΤΙΖΟΜΕΝΟΣ "SLIGHT" 16mm

ΕΑΝ	ΚΩΔΙΚΟΣ			Μ.Μ.	
	139908.0018 8W 230V	450x320mm	αλουμίνιο	τεμ.	30
	139908.0019 14W 230V	600x320mm	αλουμίνιο	τεμ.	30
	139908.0020 21W 230V	900x320mm	αλουμίνιο	τεμ.	30





### 13.11 Φωτισμός

- ΦΩΤΙΣΤΙΚΟ SENSOR "BRIDGE" 7W 230V

ΕΑΝ	ΚΩΔΙΚΟΣ		Μ.Μ.	
 5205566429073	131704.0042	αλουμίνιο	τεμ.	10

- ΛΑΜΠΑ ΦΩΤΙΣΤΙΚΟΥ SENSOR "BRIDGE" 7W 230V

ΕΑΝ	ΚΩΔΙΚΟΣ	Μ.Μ.	
 5205566451241	131704.0045	τεμ.	20



- ΦΩΤΙΣΤΙΚΟ "PRIMA DR"

ΕΑΝ	ΚΩΔΙΚΟΣ			Μ.Μ.	
 5205566777686	131704.0053 8W	600mm	αλουμίνιο	τεμ.	10
 5205566777693	131704.0054 14W	900mm	αλουμίνιο	τεμ.	10

\* Για τη λειτουργία των "PRIMA DR" χρειάζεται ο μετασχηματιστής **HUB 15W 131704.0052**

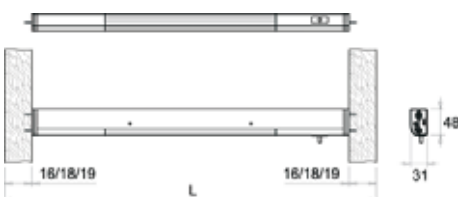

## 13.11 Φωτισμός

- ΚΑΛΩΔΙΟ ΠΡΟΕΚΤΑΣΗΣ

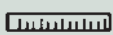
ΕΑΝ	ΚΩΔΙΚΟΣ			Μ.Μ.	
 52055664060917	131704.0016	1000mm	μαύρο	τεμ.	20



- ΜΕΤΑΣΧΗΜΑΤΙΣΤΗΣ "NANO" 6W

ΕΑΝ	ΚΩΔΙΚΟΣ	ΙΣΧΥΣ	Μ.Μ.	
 52055664777662	131704.0051	6W	τεμ.	20

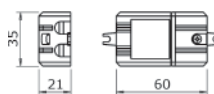

\* Τροφοδοτεί από 1 έως 4 σποτ.

- ΜΕΤΑΣΧΗΜΑΤΙΣΤΗΣ "HUB" 15W

ΕΑΝ	ΚΩΔΙΚΟΣ	ΙΣΧΥΣ	Μ.Μ.	
 52055664777679	131704.0052	15W	τεμ.	20

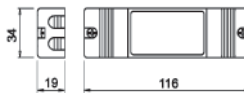

\* Τροφοδοτεί από 2 έως 10 σποτ.



- ΜΕΤΑΣΧΗΜΑΤΙΣΤΗΣ ECO60 60W

ΕΑΝ	ΚΩΔΙΚΟΣ	ΙΣΧΥΣ	Μ.Μ.	
 52055664060924	131704.0017	60W	τεμ.	20

\* Τροφοδοτεί μέχρι 3 σποτ.



- ΜΕΤΑΣΧΗΜΑΤΙΣΤΗΣ MD80 80W

ΕΑΝ	ΚΩΔΙΚΟΣ	ΙΣΧΥΣ	Μ.Μ.	
 52055664060900	131704.0015	80W	τεμ.	20

\* Τροφοδοτεί μέχρι 4 σποτ.



## 13.11 Φωτισμός

- ΜΕΤΑΣΧΗΜΑΤΙΣΤΗΣ TOUCH DIMMER TD70 70W

ΕΑΝ	ΚΩΔΙΚΟΣ	ΙΣΧΥΣ	Μ.Μ.	
	131704.0018	70W	τεμ.	10

\* Τροφοδοτεί μέχρι 3 σποτ.



### Οδηγίες σύνδεσης μετασχηματιστή "TOUCH DIMMER"

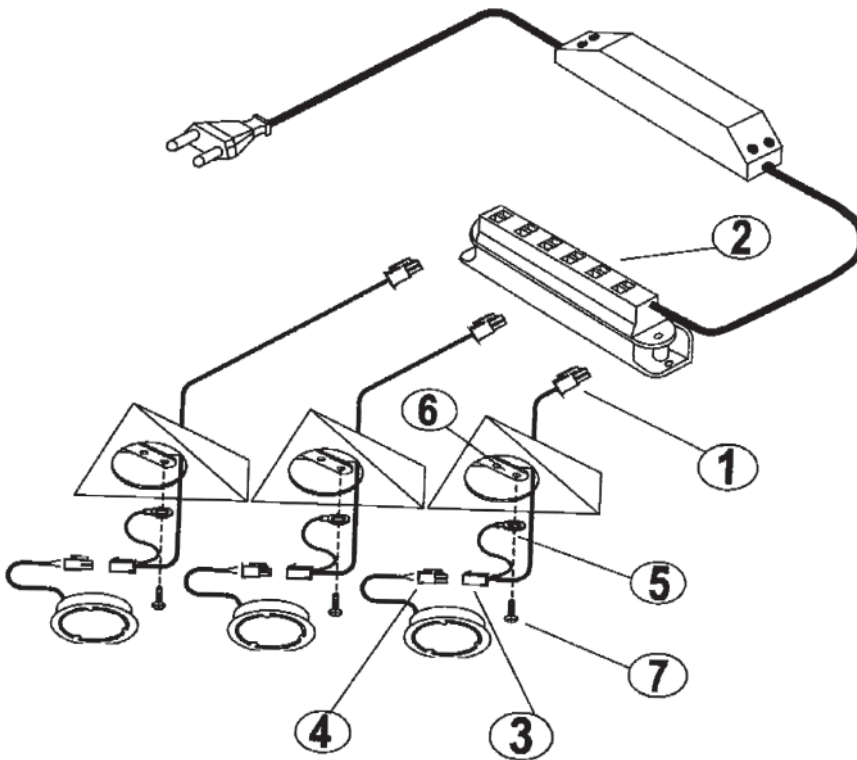

Δυνατότητα σύνδεσης με το μετασχηματιστή **TOUCH DIMMER** έχουν τα σποτ **PIRAMIDE, FREE LIGHT LW1**.

Για να συνδέσετε ένα από αυτά τα σποτ **ΕΙΝΑΙ ΑΝΑΓΚΑΙΟ** να χρησιμοποιήσετε το ειδικό καλώδιο προέκτασης που θα βρείτε μέσα στο κουτί του μετασχηματιστή. **ΔΕΝ ΠΡΕΠΕΙ** να χρησιμοποιήσετε το κανονικό καλώδιο προέκτασης που χορηγείται με τα σποτ.

Η σύνδεση πρέπει να πραγματοποιείται με τον ακόλουθο τρόπο:

Α) συνδέστε το αρσενικό βύσμα (1) του καλωδίου προέκτασης με τον διανομέα του μετασχηματιστή (2).

Β) συνδέστε το θηλυκό βύσμα (3) του καλωδίου προέκτασης με το αρσενικό βύσμα (4) του σποτ.



Γ) τοποθετήστε το καλώδιο με το μεταλλικό δίσκο (5) στον βραχίονα στήριξης του σποτ (6) ώστε να εφάπτονται και τέλος βιδώστε το μεταλλικό δίσκο στον βραχίονα με τη βίδα (7).

Δ) επαναλάβετε την ίδια διαδικασία και για τα υπόλοιπα σποτ.

Στο τέλος της σύνδεσης και κατά τη διαδικασία του ελέγχου, αν για οποιοδήποτε λόγο το φως ανάβει και σβήνει μόνο του, ρυθμίστε τον ειδικό σένσορα (+) ή (-) που βρίσκεται πάνω στο μετασχηματιστή.



13.11 Φωτισμός

- ΔΙΑΚΟΠΤΗΣ "FREE LIGHT SW1" 2,5A 250V

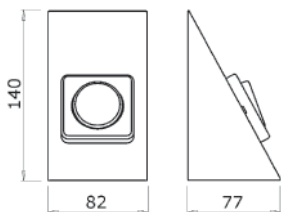
ΕΑΝ	ΚΩΔΙΚΟΣ		Μ.Μ.	
 52055664060894	131704.0014	μεταλλικό	τεμ.	20



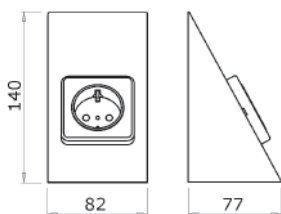

- ΠΡΙΖΑ SCHUKO "FREE LIGHT S01" 16A 250V

ΕΑΝ	ΚΩΔΙΚΟΣ		Μ.Μ.	
 52055664096237	131704.0027	μεταλλικό	τεμ.	20



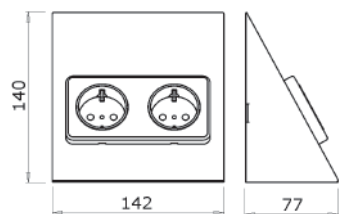

- ΠΡΙΖΑ SCHUKO ΔΙΠΛΗ "FREE LIGHT S02" 16A 250V

ΕΑΝ	ΚΩΔΙΚΟΣ		Μ.Μ.	
 52055664101146	131704.0028	μεταλλικό	τεμ.	20



- ΠΡΟΣΘΗΚΗ ΚΑΛΥΨΗΣ ΣΠΟΤ

ΕΑΝ	ΚΩΔΙΚΟΣ		Μ.Μ.	
 52055664430369	131704.0044	χρώμιο	τεμ.	20

