

15.01 Νοβοπανόβιδες

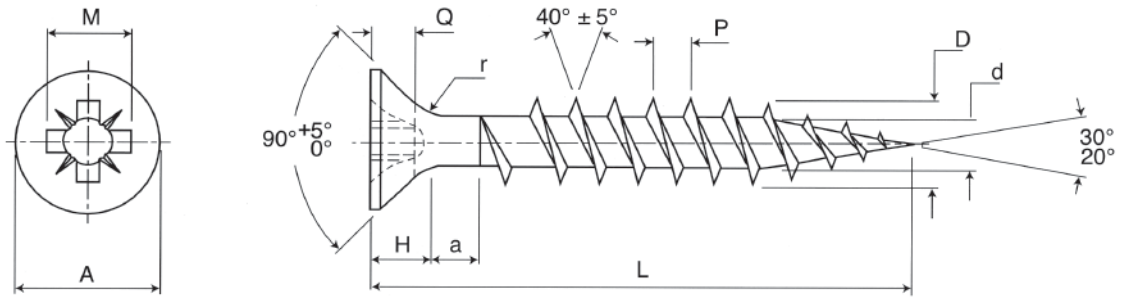

• ΤΕΧΝΙΚΑ ΧΑΡΑΚΤΗΡΙΣΤΙΚΑ

ΔΙΑΜΕΤΡΟΣ	A	H	A max	D	d	P	Q	M ref.	Drive size	R max	kg-cm	Ø
M2.5	4.70	1.40	2.10	2.25	1.10	1.10	1.22	2.51	1	1.50	10	1.85
	5.05	1.40	2.10	2.55	1.50	1.10	1.57	2.51	1	1.50	10	-0.02
M3.0	5.70	1.80	2.35	2.75	1.50	1.35	1.60	3.00	2	1.50	15	2.15
	6.05	1.80	2.35	3.05	1.90	1.35	2.11	3.00	2	1.50	15	-0.02
M3.5	6.64	2.00	2.60	3.20	1.75	1.60	1.76	4.00	2	1.80	20	2.45
	7.05	2.00	2.60	3.55	2.15	1.60	2.16	4.00	2	1.80	20	-0.02
M4.0	7.64	2.35	2.80	3.70	2.02	1.80	2.05	4.40	2	2.00	30	2.80
	8.05	2.35	2.80	4.05	2.50	1.80	2.15	4.40	2	2.00	30	-0.02
M4.5	8.64	2.55	3.00	4.20	2.22	2.00	2.46	4.80	2	2.20	44	3.15
	9.05	2.55	3.00	4.55	2.70	2.00	3.02	4.80	2	2.20	44	-0.02
M5.0	9.64	2.85	3.20	4.70	2.52	2.20	2.99	5.30	2	2.50	61	3.47
	10.05	2.85	3.20	5.05	3.00	2.20	3.55	5.30	2	2.50	61	-0.02
M6.0	11.57	3.35	3.60	5.70	3.22	2.60	2.99	6.60	3	2.50	110	4.20
	12.05	3.35	3.60	6.05	3.70	2.60	3.55	6.60	3	2.50	110	-0.02



15.01 Νοβοπανόβιδες

- ΝΟΒΟΠΑΝΟΒΙΔΑ ΣΤΑΥΡΟΥ (ΣΕ ΧΙΛΙΑΔΕΣ)

ΕΑΝ	ΚΩΔΙΚΟΣ				
 5 205566 197408	150101.0044	2.5x12mm	χρώμιο	1	48
 5 205566 197415	150101.0045	2.5x16mm	χρώμιο	1	48
 5 205566 197422	150101.0046	2.5x20mm	χρώμιο	1	32
 5 205566 251179	150101.0000	3.0x16mm	χρώμιο	1	32
 5 205566 192786	150101.0001	3.0x18mm	χρώμιο	1	32
 5 205566 192793	150101.0002	3.0x20mm	χρώμιο	1	32
 5 205566 261147	150101.0003	3.0x25mm	χρώμιο	1	16
 5 205566 192809	150101.0004	3.0x30mm	χρώμιο	1	16
 5 205566 251186	150101.0005	3.0x35mm	χρώμιο	1	16
 5 205566 192816	150101.0006	3.0x40mm	χρώμιο	1	12
 5 205566 593538	150101.0052	3.5x12mm	χρώμιο	1	48
 5 205566 593545	150101.0053	3.5x16mm	χρώμιο	1	32
 5 205566 593606	150101.0054	3.5x18mm	χρώμιο	1	32
 5 205566 648689	150101.0055	3.5x20mm	χρώμιο	1	24
 5 205566 648696	150101.0056	3.5x25mm	χρώμιο	1	16
 5 205566 648719	150101.0057	3.5x30mm	χρώμιο	1	16





15.01 Νοβοπανόβιδες

- ΝΟΒΟΠΑΝΟΒΙΔΑ ΣΤΑΥΡΟΥ (ΣΕ ΧΙΛΙΑΔΕΣ)

ΕΑΝ	ΚΩΔΙΚΟΣ				
 5205566648849	150101.0058	3.5x35mm	χρώμιο	1	12
 5205566648863	150101.0059	3.5x40mm	χρώμιο	1	8
 5205566648870	150101.0060	3.5x45mm	χρώμιο	0.5	6
 5205566648894	150101.0061	3.5x50mm	χρώμιο	0.5	6
 52055666705979	150101.0078	4.0x16mm	χρώμιο	1	32
 52055666488917	150101.0062	4.0x18mm	χρώμιο	1	24
 52055666488948	150101.0063	4.0x20mm	χρώμιο	1	16
 52055666705993	150101.0079	4.0x25mm	χρώμιο	1	16
 52055666488955	150101.0064	4.0x30mm	χρώμιο	1	12
 52055666706006	150101.0080	4.0x35mm	χρώμιο	1	12
 52055666488962	150101.0065	4.0x40mm	χρώμιο	1	8
 52055666488986	150101.0066	4.0x45mm	χρώμιο	1	8
 52055666488993	150101.0067	4.0x50mm	χρώμιο	1	6
 52055666489006	150101.0068	4.0x60mm	χρώμιο	0.5	4
 52055666489013	150101.0069	4.5x50mm	χρώμιο	1	6
 52055666489112	150101.0070	4.5x60mm	χρώμιο	0.5	3



15.01 Νοβοπανόβιδες

- ΝΟΒΟΠΑΝΟΒΙΔΑ ΣΤΑΥΡΟΥ (ΣΕ ΧΙΛΙΑΔΕΣ)

ΕΑΝ	ΚΩΔΙΚΟΣ				
	150101.0089	5.0x25mm	χρώμιο	1	12
	150101.0071	5.0x40mm	χρώμιο	1	6
	150101.0081	5.0x50mm	χρώμιο	1	4
	150101.0082	5.0x60mm	χρώμιο	0.5	3
	150101.0083	5.0x70mm	χρώμιο	0.5	3
	150101.0084	5.0x80mm	χρώμιο	0.5	2
	150101.0085	5.0x90mm	χρώμιο	0.5	2
	150101.0086	5.0x100mm	χρώμιο	0.2	2.4
	150101.0072	6.0x50mm	χρώμιο	0.2	3.2
	150101.0073	6.0x60mm	χρώμιο	0.2	2.4
	150101.0087	6.0x70mm	χρώμιο	0.2	2.4
	150101.0074	6.0x80mm	χρώμιο	0.2	1.6
	150101.0088	6.0x90mm	χρώμιο	0.2	1.6
	150101.0075	6.0x100mm	χρώμιο	0.2	1.6
	150101.0076	6.0x120mm	χρώμιο	0.2	1.6
	150101.0077	6.0x140mm	χρώμιο	0.2	1.6





15.02 Νοβοπανόβιδες Brass Plated

- ΝΟΒΟΠΑΝΟΒΙΔΑ ΣΤΑΥΡΟΥ (ΣΕ ΧΙΛΙΑΔΕΣ)

ΕΑΝ	ΚΩΔΙΚΟΣ				
	150102.0000	3.0x12mm	χρυσσαφί	1	48
	150102.0001	3.0x16mm	χρυσσαφί	1	32
	150102.0002	3.0x18mm	χρυσσαφί	1	32
	150102.0003	3.0x20mm	χρυσσαφί	1	32
	150102.0004	3.0x25mm	χρυσσαφί	1	16
	150102.0005	3.0x30mm	χρυσσαφί	1	16
	150102.0006	3.5x12mm	χρυσσαφί	1	48
	150102.0008	3.5x18mm	χρυσσαφί	1	32
	150102.0009	3.5x20mm	χρυσσαφί	1	24
	150102.0010	3.5x30mm	χρυσσαφί	1	16
	150102.0012	3.5x40mm	χρυσσαφί	1	8
	150102.0013	4.0x16mm	χρυσσαφί	1	32
	150102.0014	4.0x18mm	χρυσσαφί	1	24
	150102.0016	4.0x25mm	χρυσσαφί	1	16
	150102.0017	4.0x30mm	χρυσσαφί	1	12





15.03 Νοβοπανόβιδες Jetting



- Βαθύτερο κόψιμο στην κεφαλή και άρα μεγαλύτερη σταθερότητα στο βίδωμα.
- Πάσο στο κάτω μέρος της κεφαλής για τέλειο και γρήγορο φρεζάρισμα.
- Πάσο κατά μήκος του σπειρώματος για εύκολο βίδωμα και ποι γερή συγκράτηση.
- Μύτη με κόψιμο για πολύ γρήγορη διεύθυνση.

• **ΝΟΒΟΠΑΝΟΒΙΔΕΣ ΣΤΑΥΡΟΥ JETTING (ΣΕ ΧΙΛΙΑΔΕΣ)**

ΕΑΝ	ΚΩΔΙΚΟΣ				
	150109.0000	3.0x16mm	χρυσάφι	1	36
	150109.0001	3.0x18mm	χρυσάφι	1	36
	150109.0002	3.0x20mm	χρυσάφι	1	36
	150109.0003	3.0x25mm	χρυσάφι	1	18
	150109.0004	3.0x30mm	χρυσάφι	1	18
	150109.0005	3.0x35mm	χρυσάφι	1	18
	150109.0006	3.0x40mm	χρυσάφι	1	18
	150109.0007	3.5x12mm	χρυσάφι	1	36
	150109.0008	3.5x16mm	χρυσάφι	1	36
	150109.0009	3.5x18mm	χρυσάφι	1	36
	150109.0010	3.5x20mm	χρυσάφι	1	18
	150109.0011	3.5x25mm	χρυσάφι	1	18

15.03 Νοβοπανόβιδες Jetting

- ΝΟΒΟΠΑΝΟΒΙΔΕΣ ΣΤΑΥΡΟΥ JETTING (ΣΕ ΧΙΛΙΑΔΕΣ)

ΕΑΝ	ΚΩΔΙΚΟΣ				
	150109.0012	3.5x30mm	χρυσσαφί	1	12
	150109.0013	3.5x35mm	χρυσσαφί	1	18
	150109.0014	3.5x40mm	χρυσσαφί	1	8
	150109.0015	3.5x45mm	χρυσσαφί	1	8
	150109.0016	3.5x50mm	χρυσσαφί	1	8
	150109.0017	4.0x16mm	χρυσσαφί	1	18
	150109.0018	4.0x18mm	χρυσσαφί	1	18
	150109.0019	4.0x20mm	χρυσσαφί	1	18
	150109.0020	4.0x25mm	χρυσσαφί	1	18
	150109.0021	4.0x30mm	χρυσσαφί	1	9
	150109.0022	4.0x35mm	χρυσσαφί	1	8
	150109.0023	4.0x40mm	χρυσσαφί	1	8
	150109.0024	4.0x45mm	χρυσσαφί	1	8
	150109.0025	4.0x50mm	χρυσσαφί	1	8
	150109.0026	4.0x60mm	χρυσσαφί	0.5	4

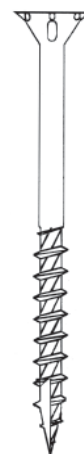



15.03 Νοβοπανόβιδες Jetting



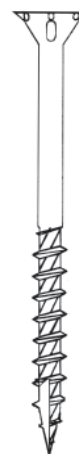

- ΝΟΒΟΠΑΝΟΒΙΔΕΣ ΣΤΑΥΡΟΥ JETTING (ΣΕ ΧΙΛΙΑΔΕΣ)

ΕΑΝ	ΚΩΔΙΚΟΣ				
	150109.0027	4.5x50mm	χρυσάφι	0.5	4
	150109.0028	4.5x60mm	χρυσάφι	0.5	4
	150109.0030	5.0x40mm	χρυσάφι	0.5	4.5
	150109.0032	5.0x60mm	χρυσάφι	0.5	4
	150109.0033	5.0x70mm	χρυσάφι	0.5	4
	150109.0034	5.0x80mm	χρυσάφι	0.2	1.8
	150109.0035	5.0x90mm	χρυσάφι	0.2	1.6
	150109.0029	5.0x100mm	χρυσάφι	0.2	1.8
	150109.0039	6.0x50mm	χρυσάφι	0.2	3.6
	150109.0040	6.0x60mm	χρυσάφι	0.2	1.8
	150109.0041	6.0x70mm	χρυσάφι	0.2	1.6
	150109.0042	6.0x80mm	χρυσάφι	0.2	1.6
	150109.0043	6.0x90mm	χρυσάφι	0.1	1.8
	150109.0037	6.0x120mm	χρυσάφι	0.1	1.8
	150109.0038	6.0x140mm	χρυσάφι	0.1	0.9



15.04 Βίδες Euro & Μετρικές

- ΒΙΔΑ EURO ΦΡΕΖΑΤΗ

ΕΑΝ	ΚΩΔΙΚΟΣ			Μ.Μ.	
 52055664035458	150108.0006	Φ6x12mm	χρώμιο	τεμ.	2000

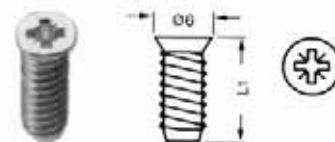

- ΒΙΔΑ EURO

ΕΑΝ	ΚΩΔΙΚΟΣ			Μ.Μ.	
 52055664024568	150108.0000	13x6mm	χρώμιο	τεμ.	2000

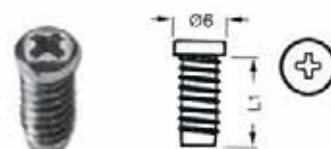

- ΒΙΔΕΣ 4ΜΑ

ΕΑΝ	ΚΩΔΙΚΟΣ			Μ.Μ.	
 52055664030804	150106.0000	4ΜΑx22mm	χρώμιο	τεμ.	1
 52055664035625	150106.0001	4ΜΑx25mm	χρώμιο	τεμ.	1
 52055664030767	150106.0003	4ΜΑx40mm	χρώμιο	τεμ.	1



15.05 Καβίλιες

- ΚΑΒΙΛΙΕΣ EURO ΞΥΛΙΝΕΣ

ΕΑΝ	ΚΩΔΙΚΟΣ			
 52055664038848	150601.0001	8x30mm	10	1
 52055664069682	150601.0002	8x35mm	10	1
 52055664028917	150601.0003	8x40mm	10	1
 52055664038831	150601.0004	10x30mm	10	1
 52055664028924	150601.0005	10x35mm	10	1





15.06 Βύσματα ράφιών

- ΒΥΣΜΑΤΑ ΡΑΦΙΩΝ

ΕΑΝ	ΚΩΔΙΚΟΣ		Μ.Μ.	
 5 205566 403093 4	175608.0000	10x145mm	τεμ.	1
 5 205566 403090 3	175608.0001	12x120mm	τεμ.	1
 5 205566 403091 0	175608.0002	14x140mm	τεμ.	1
 5 205566 403092 7	175608.0003	14x165mm	τεμ.	1



15.07 Γωνιές

- ΓΩΝΙΕΣ ΡΑΦΙΩΝ ΜΕ ΠΛΑΣΤΙΚΟ ΚΑΛΥΜΜΑ

ΕΑΝ	ΚΩΔΙΚΟΣ			Μ.Μ.	
 5 205566 403085 9	175604.0001	120mm	μαύρο	ζεύγος	1
 5 205566 403087 3	175604.0006	180mm	καφέ	ζεύγος	1
 5 205566 403990 6	175604.0003	180mm	λευκό	ζεύγος	1
 5 205566 403086 6	175604.0004	180mm	μαύρο	ζεύγος	1
 5 205566 403981 4	175604.0011	240mm	καφέ	ζεύγος	1
 5 205566 403084 2	175604.0008	240mm	λευκό	ζεύγος	1
 5 205566 403081 1	175604.0009	240mm	μαύρο	ζεύγος	1



15.07 Γώνιες

- ΜΙΚΡΕΣ ΓΩΝΙΕΣ

ΕΑΝ	ΚΩΔΙΚΟΣ			Μ.Μ.	
	150703.0000	3x3mm	χρώμιο	τεμ.	100
	150703.0001	5x5mm	χρώμιο	τεμ.	100



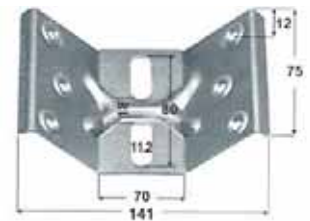

- ΓΩΝΙΑ ΤΡΑΠΕΖΙΟΥ

ΕΑΝ	ΚΩΔΙΚΟΣ			Μ.Μ.	
	150701.0000	70mm	γαλβανιζέ	τεμ.	200



- ΓΩΝΙΑ ΤΡΑΠΕΖΙΟΥ ΜΙΚΡΗ

ΕΑΝ	ΚΩΔΙΚΟΣ		Μ.Μ.	
	159906.0000	γαλβανιζέ	τεμ.	1

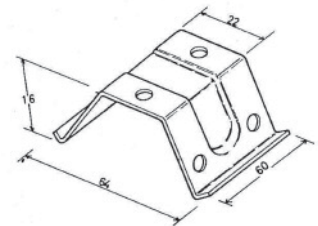

15.08 Φεράμια

ΦΕΡΑΜΙ ΜΙΝΙΟΝ Φ15



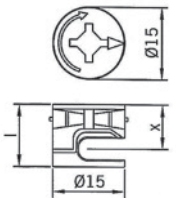
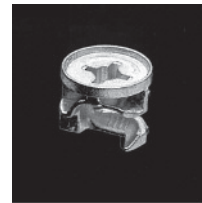

- ΦΕΡΑΜΙ ΜΙΝΙΟΝ Φ15

ΕΑΝ	ΚΩΔΙΚΟΣ			Μ.Μ.	
	150516.0001	ΓΙΑ ΞΥΛΟ 16mm	zinc plated	τεμ.	2500

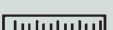

L	X
12.5	8

- ΠΕΙΡΟΙ ΣΤΑΥΡΟΥ ΓΙΑ ΦΕΡΑΜΙ Φ15mm

ΕΑΝ	ΚΩΔΙΚΟΣ			Μ.Μ.	
	150509.0002	6MAX34mm	γαλβανιζέ	τεμ.	2500



* Βιδώνει κατευθείαν στη διάτρηση Φ5mm του πλαϊνού σε σύστημα 32.



15.08 Φεράμια

- ΠΕΙΡΟΙ ΣΤΑΥΡΟΥ Μ6 ΓΙΑ ΦΕΡΑΜΙ Φ15mm

ΕΑΝ	ΚΩΔΙΚΟΣ			Μ.Μ.	
	150509.0003	6ΜΑΧ34mm	γαλβανιζέ	τεμ.	2500

* Βιδώνει στο πλαϊνό μέσα σε κάποια από τις παρακάτω φρωλιές Μ6.



- ΦΩΛΙΑ ΠΛΑΣΤΙΚΗ Μ6

ΕΑΝ	ΚΩΔΙΚΟΣ			Μ.Μ.	
	150404.0000	Φ10 6ΜΑΧ11mm	λευκό	τεμ.	1000
	150404.0001	Φ10 6ΜΑΧ13mm	λευκό	τεμ.	1000

* Για τις φρωλιές Φ11mm χρειάζεται τρύπα Φ10mm.

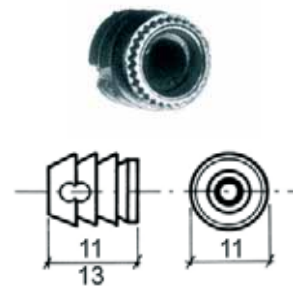

- ΦΩΛΙΑ ΠΛΑΣΤΙΚΗ Μ6

ΕΑΝ	ΚΩΔΙΚΟΣ			Μ.Μ.	
	150404.0002	Φ8 6ΜΑΧ11mm	λευκό	τεμ.	5000

* Για τις φρωλιές Φ8mm χρειάζεται τρύπα Φ8mm.

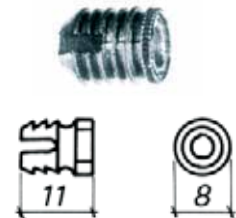

ΦΕΡΑΜΙ ΜΙΝΙΟΝ Φ16

- ΦΕΡΑΜΙ ΜΙΝΙΟΝ Φ16

ΕΑΝ	ΚΩΔΙΚΟΣ		Μ.Μ.	
	150501.0003	ΓΙΑ ΞΥΛΟ 18mm	τεμ.	2500

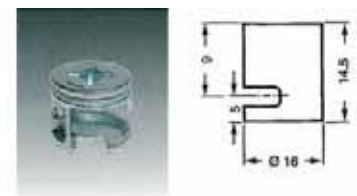



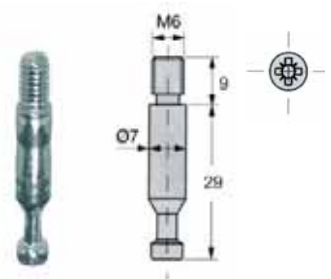

- ΠΕΙΡΟΣ ΣΤΑΥΡΟΥ ΓΙΑ ΦΕΡΑΜΙ ART.475

ΕΑΝ	ΚΩΔΙΚΟΣ		Μ.Μ.	
	150509.0004	7x38mm	τεμ.	2500

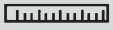

15.08 Φεράμια



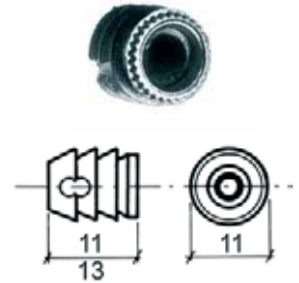

• ΦΩΛΙΑ ΠΛΑΣΤΙΚΗ Μ6

ΕΑΝ	ΚΩΔΙΚΟΣ			Μ.Μ.	
 52055661203659	150404.0000	Φ10 6ΜΑx11mm	λευκό	τεμ.	1000
 52055661210442	150404.0001	Φ10 6ΜΑx13mm	λευκό	τεμ.	1000

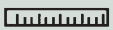

* Για τις φωλιές Φ11mm χρειάζεται τρύπα Φ10mm.

• ΦΩΛΙΑ ΠΛΑΣΤΙΚΗ Μ6

ΕΑΝ	ΚΩΔΙΚΟΣ			Μ.Μ.	
 52055661203666	150404.0002	Φ8 6ΜΑx11mm	λευκό	τεμ.	5000

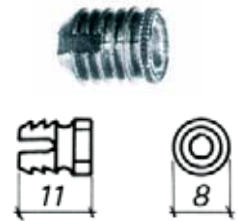

* Για τις φωλιές Φ8mm χρειάζεται τρύπα Φ8mm.

• ΕΞΩΤΕΡΙΚΑ ΦΕΡΑΜΙΑ

ΕΑΝ	ΚΩΔΙΚΟΣ		Μ.Μ.	
 52055661070312	150506.0000	λευκό	τεμ.	250
 52055661029907	150506.0001	μαύρο	τεμ.	250
 52055661029914	150506.0002	καφέ	τεμ.	250

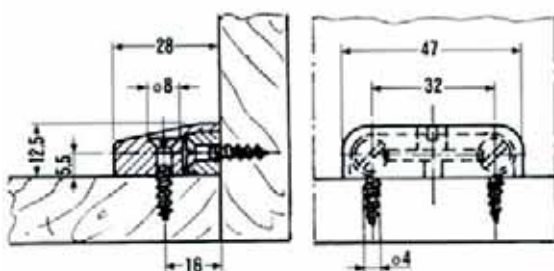

15.08 Φεράμια

- ΕΞΩΤΕΡΙΚΑ ΦΕΡΑΜΙΑ ΝΑΥΛΟΝ ΜΕ ΤΑΠΑ

ΕΑΝ	ΚΩΔΙΚΟΣ		Μ.Μ.	
	150516.0000	λευκό	σετ	1000
	150516.0002	καφέ	σετ	1000

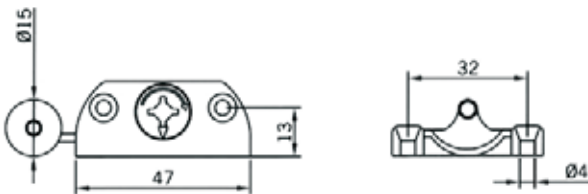

- ΕΣΩΤΕΡΙΚΑ ΦΕΡΑΜΙΑ

ΕΑΝ	ΚΩΔΙΚΟΣ		Μ.Μ.	
	150511.0000	λευκό	τεμ.	500
	150511.0001	μαύρο	τεμ.	500
	150511.0002	καφέ	τεμ.	500



- ΦΕΡΑΜΙ ΚΡΕΒΑΤΙΟΥ

ΕΑΝ	ΚΩΔΙΚΟΣ	Μ.Μ.	
	150513.0000	τεμ.	250

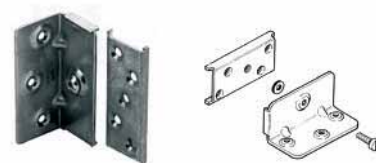

15.09 Modesty - Σύνδεση μετώπης γραφείου

Πολύ εύκολος και πρακτικός τρόπος για να συνδέουμε μετώπες σε πόδια γραφείου.

Περιστρέφοντας τα εξαρτήματα του συστήματος, μπορούμε να έχουμε εφαρμογές με μετώπες που καλύπτουν τα πόδια (εικόνα 1) καθώς και με μετώπες που αφήνουν τα πόδια εμφανή (εικόνα 2).





Εικόνα 1

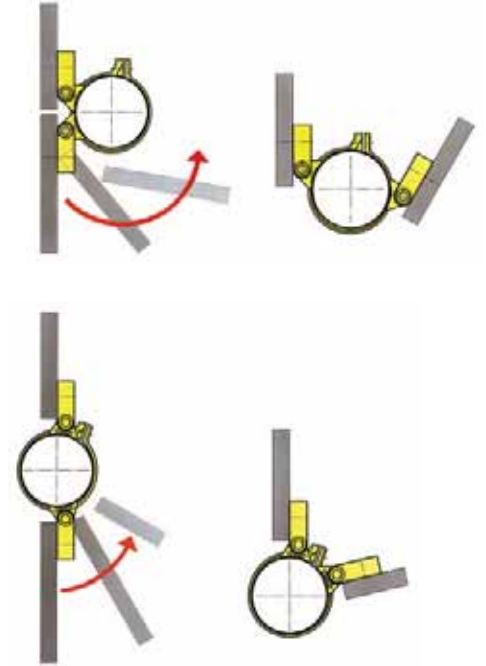

Εικόνα 2





• ΔΑΧΤΥΛΙΔΙ Φ60

ΕΑΝ	ΚΩΔΙΚΟΣ		Μ.Μ.	
 5205566187423	151001.0001	μαύρο	τεμ.	100





• ΥΠΟΔΟΧΗ ΓΑΝΤΖΟΥ

ΕΑΝ	ΚΩΔΙΚΟΣ		Μ.Μ.	
 5205566187416	151001.0000	μαύρο	τεμ.	100



• ΓΑΝΤΖΟΣ

ΕΑΝ	ΚΩΔΙΚΟΣ		Μ.Μ.	
 5205566187430	151001.0002	μαύρο	τεμ.	100



15.10 Ούπατ Eltex

- ΟΥΠΑΤ ΕΛΤΕΧ

ΕΑΝ	ΚΩΔΙΚΟΣ			Μ.Μ.	
	150201.0001	Φ4mm	γκρι	τεμ.	1000
	150201.0002	Φ5mm	γκρι	τεμ.	1000
	150201.0003	Φ6mm	γκρι	τεμ.	1000
	150201.0004	Φ7mm	γκρι	τεμ.	1000
	150201.0005	Φ8mm	γκρι	τεμ.	1000
	150201.0006	Φ10mm	γκρι	τεμ.	500



15.11 Ολόπασσα & Άγκιστρα

- ΟΛΟΠΑΣΣΑ ΑΛΕΝ

ΕΑΝ	ΚΩΔΙΚΟΣ			Μ.Μ.	
	150407.0001	12x15xM8mm	zinc plated	τεμ.	2000
	150403.0001	13x8xM6mm	zinc plated	τεμ.	1000
	150403.0005	18x15xM10mm	zinc plated	τεμ.	1000

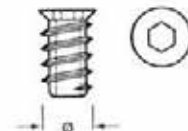

- ΑΓΚΙΣΤΡΟ

ΕΑΝ	ΚΩΔΙΚΟΣ			Μ.Μ.	
	150901.0000	6ΜΑmm	zinc plated	τεμ.	500







15.11 Ολόπασσα & Άγκιστρα

- ΦΩΛΙΑ ΣΥΝΔΕΤΗΡΑ ΜΕΤΑΛΛΙΚΗ

ΕΑΝ	ΚΩΔΙΚΟΣ			Μ.Μ.	
 5205566069507	150302.0000	Φ5mm	νίκελ	τεμ.	2000





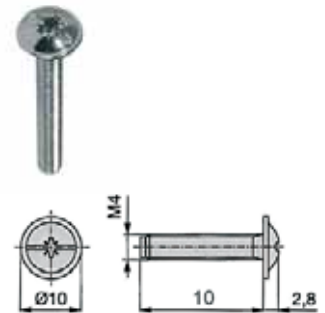

- ΒΙΔΕΣ ΣΥΝΔΕΤΗΡΑ

ΕΑΝ	ΚΩΔΙΚΟΣ			Μ.Μ.	
 5205566036073	150302.0001	4ΜΑx10mm	νίκελ	τεμ.	2000
 5205566040551	150302.0003	4ΜΑx14mm	νίκελ	τεμ.	2000



15.12 Φωλιές πλαστικές



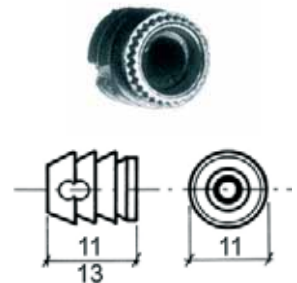

- ΦΩΛΙΑ ΠΛΑΣΤΙΚΗ Μ6

ΕΑΝ	ΚΩΔΙΚΟΣ			Μ.Μ.	
 8012314826155	150404.0000	Φ10 6ΜΑx11mm	λευκό	τεμ.	1000
 5205566210442	150404.0001	Φ10 6ΜΑx13mm	λευκό	τεμ.	1000



* Για τις φωλιές Φ11mm χρειάζεται τρύπα Φ10mm.



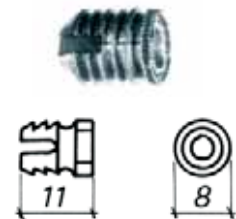

- ΦΩΛΙΑ ΠΛΑΣΤΙΚΗ Μ6

ΕΑΝ	ΚΩΔΙΚΟΣ			Μ.Μ.	
 5205566203666	150404.0002	Φ8 6ΜΑx11mm	λευκό	τεμ.	5000

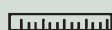

* Για τις φωλιές Φ8mm χρειάζεται τρύπα Φ8mm.

- ΦΩΛΙΑ ΠΛΑΣΤΙΚΗ

ΕΑΝ	ΚΩΔΙΚΟΣ			Μ.Μ.	
 5205566427147	150408.0000	Φ5x11mm	λευκό	τεμ.	1000

